

Third Customised ECVET Seminar for the Nuclear Energy Sector

Rome, 12 – 14 November 2014

Summary and presentations





3rd ECVET Seminar for the Nuclear Energy Sector

Hotel Nord Nuova Roma, Rome (Italy)
12 - 14 November 2014

AGENDA

(v.1-Draft) Petten, Oct 2014
F.04/MC

Wednesday 12 November 2014

OPENING SESSION

- 9:00** Introduction of the participants M. Ceclan
All
- 9:25** Practical arrangements and logistics W. Muntjewerf
- 9:30** Presentation of the 3rd ECVET Seminar M. Ceclan

WORK SESSION 1: ANALYSIS OF POSSIBLE FUNDING SOURCES

- 10:00** The funding schemes for nuclear ECVET pilot project A. Bucalossi
Questions-Discussions from NUC-VET networks All

11:30 *Coffee break*

WORK SESSION 2: NUC-VET CREDIT SYSTEM in the European context

- 11:45** ECVET fundamentals: The ECVET recommendation ECVET Team
- 12:15** Technical specifications: learning outcomes ECVET Team
- 12:45** *Lunch*
- 13:45** The ECVET qualification in the nuclear energy sector C. Chenel
- 15:00** Ways of ECVET implementation in the context
of training at higher level (EQF >5) ECVET Team
- 15:30** *Coffee break*
- 16:00** Introduction of the national NUC-VET networks M.Ceclan
All
- 17:00** *End of the first day*

Thursday 13 November 2014

WORK SESSION 3: CUSTOMIZING THE ECVET TOOLKIT FOR NES

9:00 Capitalizing the experience of existing ECVT pilot projects ECVET Team

9:45 Select key entrances and key objectives for a project (workshop) ECVET Team

10:45 *Coffee break*

11:15 ECVET toolkit customization for Nuclear Energy Sector M. Ceclan

12:30 *Lunch*

14:00 From mobility to recognize mobility ECVET Team

15:30 *Coffee break*

WORK SESSION 4: IDENTIFICATION OF THE PROCESSES THAT COULD BE TESTED AND THE NECESSARY ECVET TOOLS

16:00 Sketches of pilot projects M. Ceclan
All

17:00 *End of the second day*

19:30 *Social activity: Dinner*

Friday 14 November 2014

9:00 Identification of the processes that could be tested and the necessary ECVET tools
Expected outcomes from the national NUC-VET (E&T) networks C. Chenel

10:45 *Coffee break*

11:15 Prospective -Discussions M. Ceclan
All

11:45 Closing the Seminar JRC Team
ECVET Team

12:00 *Lunch*

3rd ECVET Customised Seminar for the Nuclear Energy Sector

Rome (Italy)

12-14 November 2014

DEBRIEFING

1. INTRODUCTION

In the context of the activities to promote the implementation of ECVET in the nuclear sector, the Institute for Energy and Transport (Joint Research Centre-European Commission) initiated in 2012, in collaboration with the ECVET-Team, the organisation of ECVET seminars customised for the nuclear energy sector. The seminars intend to spread and communicate the principles of the European Credit System for Vocational Education and Training among professionals working on human resources, education and training within the nuclear sector. This 3rd Seminar added to the dissemination of ECVET the proposal of establishing a pilot project for a practical test of the system.

2. PARTICIPANTS

The seminar was attended by 14 participants, 2 external experts, 1 internal expert and 3 organizers with a varied representation of stakeholders (industry, E&T providers, consultancies, universities, etc.) Four of them were in turn representing ongoing European projects active in the field of nuclear education and training: ENEN, ENETRAP, PETRUS and CORONA.

List of Participants

| | | |
|----------|----------------|------------------------|
| Walter | AMBROSINI | ENEN |
| Behrooz | BAZARGAN SABET | Universite de Lorraine |
| Thomas | BERKVENS | SCK-CEN |
| Andrea | BUCALOSSI | EC-JRC |
| Mihail | CECLAN | EC-JRC-IET |
| César | CHENEL RAMOS | EC-JRC-IET |
| Olivia | COMSA | CITON |
| Guido | COSTANTINI | Sogin S.p.A. |
| Concetta | FAZIO | EC-JRC-ITU |
| Alfred | HEFNER | Seibersdorf Labor GmbH |
| Jesus | IGLESIAS MORÁN | TECNATOM |
| Marinela | ILIEVA | Risk Engineering Ltd. |
| Michael | KUGLSTATTER | FTU-KIT |

| | | |
|----------------|------------|----------------------------------|
| Thierry | LEFEUVRE | ECVET Team |
| Paul | LIVOLSI | CEA- INSTN-PNSR |
| Antonio | MADONNA | ITER-Consulting |
| Willy | MUNTJEWERF | EC-JRC-IET |
| Gabriel-Lazaro | PAVEL | UPB |
| Carlo | RUSCONI | Italian School of Nuclear Safety |
| Christian | SEGOT | AREVA Training Dept. |
| Robert Hans | VAN WEZEL | ECVET Team |

3. SEMINAR SESSIONS

3.1 Introduction

INTRODUCTION TO THE SEMINAR AND OBJECTIVES (M. CECLAN)

The activities of the JRC-IET related to the implementation of the European Credit System for Vocational Education and Training (ECVET) in the nuclear energy sector make part since 2011 of the project EHRO-N (European Human Resources Observatory in Nuclear)

Since ECVET implementation in the NES is concerned, EHRO-N developed two tools:

- a) Workshop; a series of five workshops have taken place so far for the preparation of a job taxonomy.
- b) Seminar; two editions of the ECVET Seminars; the present one is the third in the series of ECVET customised seminars. The first one aimed to help the understanding of ECVET among nuclear E&T providers. In the second one a case study was used as exercise of how to define a nuclear qualification in the context of adaptation of professionals coming from other energy sectors.

The main objective of the present Seminar (3rd ECVET Seminar) is to assist the national networks to set up an ECVET pilot project or (NUCclear-VET pilot project /NUC-VET PP).

This main objective was split in four specific objectives as shown in the table below.

| Specific Objectives | Work Plan |
|--|--|
| O1) Analysis of possible funding sources | Work Session 1 |
| O2) Updating the knowledge of the ECVET fundamentals | Work Session 2: NUC-VET CS in the EU context |
| O3) Customizing the ECVET toolkit for NES | Work session 3 |
| O4) Identification of the processes that could be tested | Work session 4 |

The 3rd ECVET Seminar's work plan was developed as an answer to the Seminar objectives. A work Session was dedicated to each Specific objective.

The proposed model for a pilot project is the partnership of two national networks with members representing industry, national administration, regulatory body, and E&T providers in the respective countries. The duration would be three years and the focus would be set on the *nuclearization* of professionals by means of learning periods abroad whose outcomes would be assessed and recognised in the country of origin.

3.2 WS1: Analysis of possible funding sources

EURATOM TRAINING AND EDUCATION ACTIVITIES WITHIN HORIZON 2020 (A. BUCALOSSI)

As it is stressed in the 2004 Directive on Nuclear Safety, education and training are essential to ensure the safe operation of the nuclear facilities and fulfil the obligations established by the Euratom Treaty. Both the IAEA and the OECD-NEA have pointed out the importance of training and knowledge management to warranty the availability of competence in the near future, and human resources have been identify as one of the main risk by the European Nuclear Energy Forum. In this context ECVET can become a powerful instrument to facilitate trust, mobility and recognition and to match the needs of the industry with the competences actually demanded.

The JRC is one of the directorate generals of the European Commission involved in the application of the Euratom Treaty. Supporting the implementation of the Directive and developing nuclear education and training in different areas are among its priorities. Nuclear E&T has been undertaken in three sites of the JRC as part of the 7th Framework Programme.

The indirect actions of the Euratom Programme 2014-2020 are managed by DG RTD, being the budget allocated to fission and radiation protection around one third of the total (316 million €) The calls launched in 2014 are now in the evaluation and negotiation stage.

Erasmus+ and Marie Skłodowska-Curie actions offer funding possibilities non-specific of the nuclear sector.

3.3 WS2: Updating the knowledge on ECVET fundamental

INTRODUCTION TO THE ECVET INITIATIVE (R. VAN WENZEL)

The ECVET Team carries out dissemination activities to promote the implementation of ECVET. It maintains a website and releases a quarterly newsletter, where an article on the nuclear ECVET was published in the issue of June 2014.

The ECVET initiative has to be understood in the context of the Strategy 2020 for a smart, sustainable, and inclusive growth, aimed to respond to the evolvments in the global economy and labour markets. Career paths are nowadays shaped differently, demanding continuous update and adaptation. Key competences such as literacy in I&C technologies and communication in foreign languages have become essential for practically every professional. ECVET, together with other initiatives as EQAVET, EQF, ESCO and Europass, strives to provide a setting that fosters lifelong learning, transparency, mobility and permeability.

The nuclear sector represents a singular case, since is the only one with the focus mainly set at the higher qualification levels (EQF 6 and above) The inclusion of nuclear occupations and

competences in the ESCO thesaurus could be very beneficial for the visibility of the sector and to provide added value to the outcomes achieved.

THE ECVET RECOMMENDATION (T. LEFEUVRE)

The Recommendation 2009/C 155/02 provides a technical framework to enable the transfer, recognition and accumulation of learning outcomes in order to facilitate the achievement of a qualification. It does not prescribe the application of a complete fixed system, but proposes a set of tools that can be taken separately depending on the user's needs. They comprise principles for the description of qualifications, processes for transfer and accumulation and a set of documents for the register of those processes.

LEARNING OUTCOMES AND UNITS (T. LEFEUVRE, R. VAN WENZEL)

The shift to learning outcomes (LOs) when defining qualifications is meant to enhance the quality and transparency of qualifications, reinforcing their link with the labour market. They are associated to the competence concept and the correspondence to the EQF descriptors makes them transparent and comparable.

The LOs are grouped in units, consisting of coherent sets of learning outcomes that provide a credit for the learner when it is achieved and validated. The units are used in different ways in the different education systems, since there are different criteria for their design. They can reflect the competences required for several related tasks included in the given occupation or they can encompass contents within a certain field of knowledge. Moreover there are crosscutting units and others that are specific of a qualification. The size of the units has implications in the learning process, the assessment and the mobility.

The ECVET points attributed to units are meant to provide additional information but are not a core element of the system and they are not used at all in some cases. They are not related to credit, which corresponds to the learner's achievement.

THE ECVET QUALIFICATION IN THE NUCLEAR SECTOR (C. CHENEL)

ECVET aims to a better match of the qualifications with the needs of the labour market and the competences required in jobs. The learning process is conceived in a different way, being output focused and centred in the learner, and aiming to the acquisition of competence and know-how instead of a mere accumulation of knowledge. The qualifications are closely related to the job requirements, which are defined in the three components of competence: knowledge, skill and attitude –although the use of these concepts can lead sometimes to terminological confusion. Learning enlarges the traditional concepts of education and training and becomes a lifelong and life-wide process that may take place in any context.

The nuclear job taxonomy establishes job requirements for typical positions in a nuclear power plant. It is meant to be used for the definition of learning outcomes and nuclear qualifications. Although there is not a unique way to prepare LOs, they should include an action verb and be formulated to be concrete and measurable.

The specific features of the nuclear energy might be relevant for determining the approach to tackle issues related to training, competence building and knowledge management. Prompted to identify those possible particularities, the participants mentioned the following: Role of

different stakeholders; International cooperation; Technical complexity and specificity; Safety culture; Need for responsibility and continuity in jobs; The different national regulatory frameworks and/or their need of harmonisation; Mutual recognition restricted by safety assurance; Need to attract young students and professionals to ensure workforce availability; Relevance of high EQF qualifications; Need for continuous update of competence.

Considering these specificities, the participants were asked about potential benefits and possible barriers stemming from the implementation of ECVET in the nuclear sector.

BARRIERS: Conservative management of nuclear powers plants; Obstacles to gain the participation of regulators and public institutions; Lack of experience; Different national education systems; Technology differences; Different regulatory regimes; Difficulty for HE providers to assess competences;

BENEFITS: Enlarged market for funding of traineeships; Larger job market for professionals; Fostering in depth analysis of job requirements and soft skills; Flexibility; Improved cooperation between companies; Harmonisation; Facilitating *nuclearization*; Common approach for LOs; Better definition of qualification and identification of competence gaps.

INTRODUCTION OF THE NATIONAL AND EUROPEAN NETWORKS (M. CECLAN)

The call for the Seminar requested the attendants to represent a national network that could become a partner in a pilot project. The suggested composition was at least four actors, with presence of E&T providers, national administration, regulators and industry. Besides these national networks, three European platforms are represented too.

THE EUROPEAN NETWORK ON EDUCATION AND TRAINING IN RADIOLOGICAL PROTECTION – ENETRAP (T. BERKVENNS)

ENETRAP is a FP7 project of the Euratom Fission Training Schemes participated by thirteen international partners and a consultancy group. It has the purpose of developing the European reference training scheme for radiation protection experts, including the implementation of ECVET principles and testing mutual recognition.

PROGRAMME FOR EDUCATION, TRAINING AND RESEARCH ON UNDERGROUND STORAGE– PETRUS (B. BAZARGAN SABET)

Petrus III is a consortium formed by 21 partners of twelve European countries. Its work packages WP1 and WP2 consist of the development and implementation of a competence-based PD programme on radioactive waste disposal using ECVET principles and tools. The design of the programme is based in the input of stakeholders to carry out job and task analysis in order to define the training needs adapted to the trainee profile. The certification of the final qualification combines the assessment of previous experience with the completion of dedicated training modules. Memorandum of Understanding and Learning Agreement are used to ensure recognition of the outcomes achieved by the learner.

ESTABLISHMENT OF A REGIONAL CENTER OF COMPETENCE FOR VVER TECHNOLOGY AND NUCLEAR APPLICATIONS– CORONA (M. ILIEVA)

CORONA has the objective of harmonise training schemes on VVER technology and align them with IAEA guidelines and therefore enhancing the safety in the operation of the Eastern country reactors.

THE EUROPEAN NUCLEAR EDUCATION NETWORK - ENEN (W. AMBROSINI)

ENEN was created with the objective of preserving and developing nuclear expertise and promoting the implementation of the Bologna process for nuclear studies, and therefore to overturn the decline experienced by the nuclear E&T. It was formalised as association in 2003. In March 2013 it had 64 members from 22 countries. ENEN promotes diverse training activities oriented to bridge the universities with the industry. The European Master of Science in Nuclear Engineering brings together European industry, universities and research facilities and provides qualification that promotes a common safety culture. It is not an official diploma, but its transparency and quality makes it widely recognised by the industry.

The implementation of ECVET it has to start with the initiative of the sector, which would be followed by national administration, as it was the case for ECTS.

ENEN has a long experience in leading European projects and might serve as umbrella for the development of a nuclear ECVET pilot project, starting with the creation of a working group.

THE ROMANIAN NUCLEAR VET NETWORK – RO-NUVET (O. COMSA)

The Romanian network has eleven partners, being among them the national regulator, the Cerdanova NPP and the national agency for waste management, several universities, research institutes and training providers. The main issue at national level is the lack of new graduates and the migration of the few coming out from the education system. The only NPP in the country has its enlargement project in standby and it hardly demands any new staff. Just graduated students find job opportunities in other countries running CANDU reactors – namely Canada and Korea.

GERMANY (M. KUGLSTATTER)

There is not a national network but small associations that meet periodically. Some of them carry out cooperation activities with Romania.

ITALY (G. CONSTANTINI)

There is not a network in Italy yet, properly speaking. Sogin has detected the need of continuous training for its staff and has developed programmes in safety and radioprotection. In 2009, as a result of the possibility that the nuclear program was resumed, actions in E&T were reactivated with the initiation of collaboration with the University of Pisa and ENEN. There is a strong interest to promote standardised training with international recognition, covering a wide scope of technologies and targeting all professional levels, including technicians.

SPAIN (J. IGLESIAS MORÁN)

Although there is no formal network, nuclear energy companies and other stakeholders join in the CEIDEN platform. They offer a catalogue of training and some of its members are involved in European projects.

FRANCE (P. LIVOLSI)

The organisation of a national network would be supported by AREVA, the major operator. France has a big nuclear sector, employing some 300.000 people, and still needs to increase the workforce for the upcoming undertakings (post stress tests, *grand carénage*)

Training programs should be based in job standards and associated competences. The application of ECVET principles is compatible with the Systematic Approach to Training (SAT) recommended by the IAEA. Databases and other IT tools are needed to monitor the learning process and manage qualifications. Big corporations have developed this type of tools for their internal management.

3.4 WS3: Customising the ECVET toolkit for the nuclear energy sector

CAPITALISING THE EXPERIENCE OF THE EXISTING PROJECTS (R. VAN WENZEL, T. LEFEUVRE)

The Sector Skills Alliances are meant to define training needs in the given sector and design and deliver common curricula consequently. Their partners are VET providers, entities relevant because of their specific expertise or representative role, and organisms with regulatory function in education systems.

The permeability between ECTS and ECVET is still to be address. This should be achieved through a dialogue about the political and technical conditions to allow transfer and recognition, with the focus set in the mobility of the learners.

ECVET is a technical framework aimed to promote flexibility in mobility and lifelong learning. It relies in the adoption of learning outcomes that provide the necessary transparency to ensure trust and, therefore, transfer and recognition.

NETINVET is a network of companies and training providers in the field of trade and logistics. It has established mechanisms to ensure mutual trust and facilitate international mobility of learners. They have achieved 350 mobility operations in 2013. The main difficulties encountered are related to differences in the way to formulate curricula, language, duration and periods to fit the mobility and different assessment practices.

ECVET TOOLKIT CUSTOMISATION FOR THE NUCLEAR SECTOR (M. CECLAN)

There have been several pilot projects on the implementation of ECVET in other sectors. Taking their example can help to define the outline of a nuclear project. The ideal composition for a participant national network would consist of: industry representative, E&T provider, national administration and regulatory body. The project would develop over 3 years, encompassing 4 stages:

- Selection of professions to "nuclearize"
- Determine the learning outcomes to achieve during the mobility
- Learning period abroad

- Assessment and recognition of the learning outcomes

Among preconditions for a successful outcome are the sound understanding of the ECVET concepts by the actors involved and the appropriate language skills of the learner.

Taking the practical example of the qualification as Senior Reactor Operator, the tasks can be found in the corresponding job description. Each function can correspond to a unit, for which learning outcomes have to be formulated covering the competences required, together with the assessment methods. For the achievement of all the units, a learning program is finally defined, including classroom and in-the-job training and supervised work practice.

WORKSHOP ON MOBILITY (R. VAN WENZEL, T. LEFEUVRE, ALL)

The participants were divided in two groups that had to answer alternatively to questions related to mutual trust in proposed cases of mobility.

How to document the learning outcomes achieved?

- Learning agreement, containing: Unit content and learning outcomes, assessment methods and criteria, assessment results with evidence.
- Record in the personal transcript of the learner.

What are the conditions for assessment in the perspective of transfer and recognition?

- Mutual agreement between institutions, including: LOs, assessment methods and criteria; trainers; assessment evidence.
- Language recognition

3.5 WS4: Identification of processes to be tested

CONCEPT, PROCESSES AND OUTCOMES OF NUCLEAR PILOT PROJECT (C. CHENEL)

The participants were faced with several key questions to define a nuclear ECVET project on six major topics:

1. Funding Schemes The Euratom programmes seem the most feasible opportunity although others like Sector Skills Alliance and Erasmus+ could be possible. It is necessary too to follow the possible calls from technology platforms.

2. New project, embedded or crosscutting network

3. Integrating other E&T initiatives together with ECVET

4. Necessary partners The involvement of regulators and TSOs is mandatory. The IET plans a dedicated seminar or meeting with ENSREG.

5. Targeted learners and types of learning The main asset would be to provide instruments to facilitate *nuclearization* of professionals. Training for the trainer is also essential and has a great impact. Modern programmes, using online learning tools, and

flexible pathways would increase the attractiveness of the sector. Qualifications related to decommissioning have the advantage of being needed also in countries with past or phasing out nuclear programs.

6. Processes and outcomes Creation of dedicated IT tools: there are tools already developed. Within the nuclear industry most operators have developed software for the management of jobs and training, but sharing is not easy. A first step would be identifying the jobs that can be used as reference profiles. The qualification should reach EQF 6-7 at least to check how the system works at those levels. The greater potential is in application to continuous learning, to achieve the recognition of professional development.

SKETCHES OF PILOT PROJECTS – INTRODUCTION (M. CECLAN)

For the setting up of a nuclear ECVET pilot project the participants are invited to present their proposals, including the networks involved, one or more examples of *nuclearization* learning, the learning outcomes to achieve in a mobility period and other methodological aspects.

ENETRAP III NUC-VET PILOT PROJECT (T. BERKVEN)

For the implementation of the Council Directive 96/29 on radiological protection training programs has been developed in the member states, following different approaches and using diverse terminology. The new Directive 2013/59, which defines the figures of Radiation Protection Expert, Radiation Protection Officer and Medical Physics Expert, is the reference framework for the project ENETRAP III.

The project aims to apply innovative approaches in training, incorporating the ECVET principles with the assistance of the regulators for the endorsement of the proposed training. The outcomes of ENETRAP II, with the development of more than 500 learning outcomes, will be used to design a reference training scheme adaptable for the different specialisations. This will represent an important assistance for the implementation of the directive in the member states.

ESTABLISHMENT OF A REGIONAL CENTRE OF COMPETENCE FOR VVER TECHNOLOGY AND NUCLEAR APPLICATIONS– CORONA (M. ILIEVA)

CORONA includes 9 partners and its objective is ensuring the safety of nuclear installations with VVER technology by means of continuous training of their staff and preservation of existing knowledge. This has been done by organising dedicated courses targeting different categories of trainees, from nuclear specialists, to managers and students. A web portal has been created also for an easy access to resources and sharing information. Testing the implementation of ECVET with a pilot experience is the goal of the WP3, which plans to practice a mobility exercise of a trainee.

THE ANNETTE PROPOSAL (W. AMBROSINI)

The proposal, submitted for the Euratom call NFRP-10, aims to strengthen the existing networks and to consolidate and further develop the achievements of the past projects. It presents eight work packages, being WP4 focus on cross border transfer of expertise by means of the application of ECVET in industry. The project has 27 participants and has the

vocation of being an open undertaking, establishing synergies with other networks and organisations.

4. MEETING WITH THE EUROPEAN NETWORKS

A final meeting was held with the participants involved in European networks. There was a common agreement in the need to initiate a regular communication to share the outcomes achieved so far and study common undertakings, namely the development of databases and software for the design and management of learning outcomes and qualifications. The JRC-IET shall plan a first meeting for the beginning of 2015, for which the list of networks and contact persons was defined.

5. DISCUSSION AND CONCLUSIONS

The Seminar has provided updated knowledge on the ECVET initiative and has given the opportunity for a first assessment on the technical and practical aspects for setting up a dedicated European pilot project. The awareness and understanding on ECVET has noticeably improved over the last two years. The continuation with future customised seminars would be very beneficial.

The update from ongoing initiatives and the analysis of the specific needs and characteristics of the nuclear sector has produced the insight required to set up the basis of an ECVET project. For a successful pilot project, the involvement of the regulatory bodies and the main actors of the industry is essential. Moreover, the association of more instances of the European Commission is also desirable. The endorsement of the regulators would drive the commitment of the industry.

Efforts in communication are necessary to increase awareness and commitment of more stakeholders. The EHRO-N website might become a reference point of exhaustive and updated information. In parallel, periodical meetings among the nuclear E&T projects would allow coordination of activities and sharing experiences. Visibility might improve by exposing the ECVET related activities in international conferences.

Proposed actions:

- Planning of a 4th Seminar to take place during 2015 (tentative last week of September in Vienna)
- Establishing a framework of regular communication with ENSREG and FORATOM
- Initiating periodical meetings among the nuclear E&T projects and platforms; first one during the first quarter of 2015.
- Improving the communication with stakeholders interested in ECVET implementation through the JRC-IET website.
- Collaboration with DG-RTD in order to prepare a dedicated call (under Horizon 2020/ EURATOM) for NUC-VET pilot projects.

3rd ECVET Seminar – customized for Nuclear Energy Sector



Introduction of the participants'

1. ECVET Seminar's story



An initiative of the European Human Resources Observatory
for the Nuclear Energy Sector (EHRO-N)



Sponsored by



1. ECVET Seminar's story



Recognized partner of IAEA KM activities: TecDocs, KM Schools, Multimedia Tools, HR (cf. DDG Nuclear Energy A. Bychkov)

ECVET: European Credit System for Vocational Education and Training
The second major reform of European E&T systems after ECTS.





EHRO-N Project: **ECVET implementation in the NES**

Workshop

ECVET Seminar

| Year | Place | Purpose |
|------|---------------------------|---|
| 2011 | Bergen, NL Oct 2011 | Preparation of a nuclear job taxonomy / The shift from KB-QS to CB-QS |
| 2012 | Petten, NL Feb 2012 | |
| | Thessaloniki, GR Oct 2012 | |
| 2013 | Bergen, NL May 2013 | |
| | Madrid, ES Nov 2013 | |

| Place | Purpose |
|---------------------------|--|
| | |
| Brussels, BE Sept 2012 | To assist the NUC-VET providers in understanding the ECVET |
| | To support the NUC-VET providers for creating networks |
| Budapest, HU Oct 2013 | First exercise on designing: nuclear qualification; Learning Units/LU; LOs |
| Rome, IT Nov. 2014 | to support national NUC-VET networks →setting up ECVET pilot projects |

2. Participants' introduction



3rd ECVET Seminar for NES

Organization

Good science \approx good Seminar

Participants



2. Participants' introduction



3rd ECVET Seminar for NES

Organization

Good science \approx good Seminar

Participants

| | |
|--------------------------|--------------------------|
| B. BAZARGAN SABET | M. KUGLSTATTER |
| Th. BERKVENS | P. LIVOLSI |
| O. COMSA | A. MADONNA |
| G. CONSTANTINI | G.L. PAVEL |
| C. FAZIO | L. PYRONKOV |
| A. HEFNER | P. PORRAS DIEGUES |
| J. IGLESIAS MORAM | C. RUSCONI |
| M. ILIEVA | C. SEGOT |

2. Participants' introduction



3rd ECVET Seminar for NES

Organization

Good science \approx good Seminar

Coordinator

Participants



B. BAZARGAN SABET

**M.
KUGLSTATTER**

Th. BERKVENS

P. LIVOLSI

O. COMSA

A. MADONNA

G. CONSTANTINI

G.L. PAVEL

C. FAZIO

L. PYRONKOV

A. HEFNER

**P. PORRAS
DIEGUES**

J. IGLESIAS MORAM

C. RUSCONI

M. ILIEVA

C. SEGOT

2. Participants' introduction



3rd ECVET Seminar for NES

Organization

Good science \approx good Seminar

Coordinator

Participants

Robert Hans van WEZEL

Thierry LEFEUVRE

Andrea BUCALOSSI

B. BAZARGAN SABET

M.
KUGLSTATTER

Th. BERKVENS

P. LIVOLSI

O. COMSA

A. MADONNA

G. CONSTANTINI

G.L. PAVEL

C. FAZIO

L. PYRONKOV

A. HEFNER

P. PORRAS
DIEGUES

J. IGLESIAS MORAM

C. RUSCONI

M. ILIEVA

C. SEGOT

2. Participants' introduction



3rd ECVET Seminar for NES

Organization

Good science \approx good Seminar

Coordinator

Participants

Robert Hans van WEZEL

Thierry LEFEUVRE

Andrea BUCALOSSI

B. BAZARGAN SABET

P. LIVOLSI

Th. BERKVENS

A. MADONNA

O. COMSA

G.L. PAVEL

G. CONSTANTINI

L. PYRONKOV

C. FAZIO

**P. PORRAS
DIEGUES**

A. HEFNER

R. REZAC

J. IGLESIAS MORAM

C. RUSCONI

M. ILIEVA

C. SEGOT

M. KUGLSTATTER



2. Participants' introduction



3rd ECVET Seminar for NES

Organization

Good science \approx good Seminar

Coordinator

Participants

Willy MUNTJEWERF

Robert Hans van WEZEL

Cesar CHENEL-RAMOS

Thierry LEFEUVRE

Mihail CECLAN

Andrea BUCALOSSI

B. BAZARGAN SABET

P. LIVOLSI

Th. BERKVENS

A. MADONNA

O. COMSA

G.L. PAVEL

G. CONSTANTINI

L. PYRONKOV

C. FAZIO

P. PORRAS
DIEGUES

A. HEFNER

R. REZAC

J. IGLESIAS MORAM

C. RUSCONI

M. ILIEVA

C. SEGOT

M. KUGLSTATTER

2. Participants' introduction



3rd ECVET Seminar for NES

Organization

Good science \approx good Seminar

Coordinator

Participants

Willy MUNTJEWERF

Robert Hans van WEZEL

Cesar CHENEL-RAMOS

Thierry LEFEUVRE

Mihail CECLAN

Andrea BUCALOSSI

B. BAZARGAN SABET

P. LIVOLSI

Th. BERKVENS

A. MADONNA

O. COMSA

G.L. PAVEL

G. CONSTANTINI

L. PYRONKOV

C. FAZIO

P. PORRAS
DIEGUES

A. HEFNER

R. REZAC

J. IGLESIAS MORAM

C. RUSCONI

M. ILIEVA

C. SEGOT

M. KUGLSTATTER

Introducing your self:

- **Name**
- **Affiliation**
- **ECVET related experience**



3rd ECVET Seminar – customized for Nuclear Energy Sector

*Hotel-Nord Nuova Roma
Rome (IT) 12-14 November 2014*



Work Plan and Methodology



- 1. JRC/EHRO-N sectorial approach on ECVET implementation**
- 2. The 3rd ECVET Seminar: objectives & WP**
- 3. The NUC-VET pilot project outline**
- 4. Methodological aspects**





- **Sectorial strategy & road map:**

- √ **JRC** developed a **strategy & road map** for ECVET implementation in NES

- √ **Article:**

- **published in:** ECVET Magazine-June issue

- **title:**

- posted on the ENEN website:

<http://www.enen-assoc.org/en/training/jrc-ehro-n/the-road-map-for-ecvet-i.html>

- √ ECVET concept for the NES → customised as **NUClear-VET credit system/ NUC-VET CS** → implementation of **NUC-VET CS** is a stepwise process



Mihail Ceclan, Ulrik Von Estorff - European Commission, Joint Research Centre, Institute for Energy and Transport - The Netherlands

**The road map for
ECVET implementation
in the nuclear energy sector**



- **The road map for NUC-VET CS implementation:**

- ✓ **NUC-VET Credit System** has **five components**
 - the **NUC-VET CS** would be assembled in **six steps**
- ✓ First component..... → for a better understanding of skill gap in the nuclear industry → **more additional data in next slide**

The NUC-VET CS components & the JRC road map for NUC-VET implementation

| No | Component | Activities | Findings/Achievements |
|----|--|---------------------------|--|
| 1 | Scanning the HR demand & supply of the NES | 1 st EHRO-N survey - 2012 | • by 2020- deficit of 40 % nuclear experts |

- The Gap between the Demand & Supply in the NES:

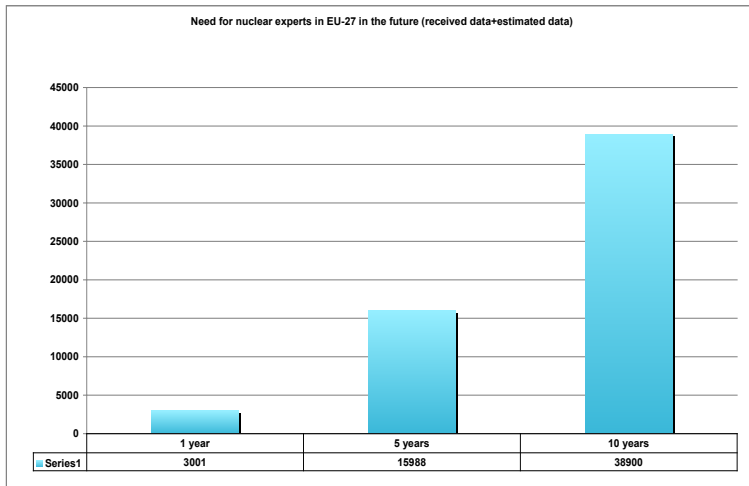
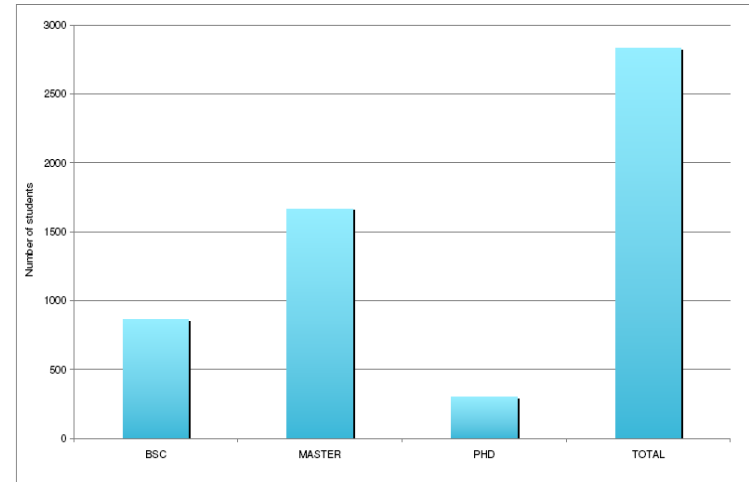
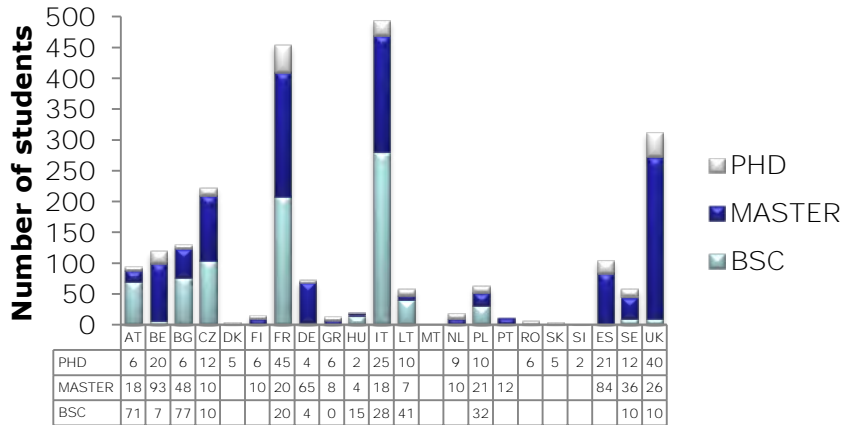

In 2012 Gap = 25%
By 2020 Gap = 40%
The Gap covered by nuclearization



The NUC-VET CS components and the JRC road map for ECVET implementation

| No | Component | Activities | Findings/Achievements |
|----|--|---------------------------|--|
| 1 | Scanning the HR demand & supply of the NES | 1 st EHRO-N survey - 2012 | • by 2020- deficit of 40 % nuclear experts |

The road map for ECVET implementation in the NES:

- √ Six major components of the **NUC-VET Credit System** → that would be assembled in six steps
- √ (1) **HR Demand-Supply analysis**:
 - **"nuclearization"** the main HR process in the nuclear sector → the way of filling up the GAP
 - starting the **"nuclearization"** process → opportunity to shift from KB- QS to CB-QS/ **ECVET implementation in the NES**



The road map for ECVET implementation in the NES:

- √ Six major components of the **NUC-VET Credit System** → that would be assembled in six steps
- √ First component.....
 - **"nuclearization"** the main HR process in the nuclear sector → the way of filling up the GAP
 - starting the **"nuclearization"** → opportunity to shift from KB- QS to CB-QS/ **ECVET implementation in the NES**

√ The components 2 & 3

- (2) shift from KB- QS to CB-QS → **achieved by developing of a NJT**
- (3) developing CB-QS → **to structure nuc. qualif. in LU&LOs**

The NUC-VET CS components and the JRC road map for ECVET implementation

| No | Goal | Activities | Findings/Achievements |
|----|--|---|---|
| 1 | Scanning the HR demand & supply of the NES/ market | 1 st EHRO-N survey - 2012 | • by 2020- deficit of 50 % nuclear experts |
| 2 | The shift from KB-QS to CB-QS | <ul style="list-style-type: none"> • Nuclear Job Taxonomy • JD-job requirements KSC | <ul style="list-style-type: none"> • 155 jobs; • 140-JD |
| 3 | Developing competence based-qualification system for NES | Designing nuclear qualifications based on ECVET approach | 1 st exercise on designing NPP Operator qualifications at 2 nd ECVET Seminar - Budapest, HU (Oct. 2013) |



• The road map for ECVET implementation in the NES:

- √ Six major components of the **NUC-VET Credit System** → that would be assembled in six steps
- √ **First component.....** → "**nuclearization**" the main HR process in the nuclear sector
- √ **The components 2 & 3**
 - (2) shift from KB- QS to CB-QS → **achieved by developing of a NJT**
 - (3) developing CB-QS → **to structure nuc. qualif. in LU&LOs**
- √ **The components 4 & 5**
 - The links DG RTD& DG JRC on **ECVET implementation in the NES:**
 - indirect actions/DG RTD (some of you are involved in the EFTS projects)
 - direct actions/DG JRC

The NUC-VET CS components and the JRC road map for ECVET implementation

| No | Goal | Activities | Findings/Achievements |
|----|--|--|--|
| 1 | Scanning the HR demand & supply of the NES | 1 st EHRO-N survey - 2012 | • by 2020- deficit of 50 % nuclear experts |
| 2 | The shift from KB-QS to CB-QS → from knowledge creation to competence building | <ul style="list-style-type: none"> • Nuclear Job Taxonomy • JD-job requirements → in terms of KSC • Competence Catalogue: KSC/A | <ul style="list-style-type: none"> • 155 jobs; • 140-JD • 2200 new entries All these aims to serve as a tool for defining learning outcomes |
| 3 | Developing competence based-qualification system for NES | Designing nuclear qualifications based on ECVET approach | 1 st exercise on designing NPP Operator qualifications at 2 nd ECVET Seminar - Budapest, HU (Oct. 2013) |
| 4 | The development of the mobility tools for NES | memoranda of understanding, learning agreements and learners' transcripts of records; | <ul style="list-style-type: none"> • Developed through the indirect actions (EFTS projects) supported by the DG RTD |
| 5 | The qualification achievement process for NES | Developing specific tools for assessment, validation, recognition and accumulation of learning outcomes. | |



• The road map for ECVET implementation in the NES:

- √ Six major components of the **NUC-VET CS** → that would be assembled in six steps
- √ **The step 6: Supporting**
 - having the main components of the **NUC-VET CS** → need for testing how these work together
 - through a **NUC-VET pilot project** → test/PP should be done **at national level** → in the context of mobility
- √ **Summarizing:** having the whole picture of ECVET implementation in the NES → **3rd ECVET Seminar content**

The NUC-VET CS components and the JRC road map for ECVET implementation

| No | Goal | Activities | Findings/Achievements |
|----|--|--|--|
| 1 | Scanning the HR demand & supply of the NES/ market | 1 st EHRO-N survey - 2012 | • by 2020- deficit of 50 % nuclear experts |
| 2 | The shift from KB-QS to CB-QS → from knowledge creation to competence building | <ul style="list-style-type: none"> • Nuclear Job Taxonomy • JD-job requirements defined in terms of KSC • Competence Catalogue: KSC/A | <ul style="list-style-type: none"> • 155 jobs; • 140-JD • 2200 new entries All these aims to serve as a tool for defining learning outcomes |
| 3 | Developing competence based-qualification system for NES | Designing nuclear qualifications based on ECVET approach | 1st exercise on designing NPP Operator qualifications at 2nd ECVET Seminar - Budapest, HU (Oct. 2013) |
| 4 | The development of the mobility tools for NES | memoranda of understanding, learning agreements and learners' transcripts of records; | <ul style="list-style-type: none"> • Covered through the indirect actions (EFTS projects) supported by the DG RTD |
| 5 | The qualification achievement process for NES | Developing specific tools for assessment, validation, recognition and accumulation of learning outcomes. | |
| 6 | Supporting NUC-VET networks in setting up an ECVET PP | <ul style="list-style-type: none"> • by 5 WS • by 2 ECVET seminars | <ul style="list-style-type: none"> • testing the ECVET implementation → NUC-VET Pilot pr. |

2. The 3rd ECVET Seminar

Objectives and Work Plan



| Objectives | | Work Plan |
|----------------------------|--|---|
| Main objective | To support the national networks to set up an ECVET pilot project/ NUClear-VET pilot project /NUC-VET PP | |
| Specific objectives | O1) Analysis of possible funding sources | Work Session 1: |
| | O2) Updating the knowledge of the ECVET fundamentals | Work Session 2: NUC-VET CS in the EU context |
| | O3) Customizing the ECVET toolkit for NES | Work session 3: |
| | O4) Identification of the processes that could be tested | Work session 4: |
| | The Seminar is facilitated by: 2 ECVET experts from ECVET Team; 1 expert from JRC HQ | |

ECVET for the Nuclear Energy Sector

3rd ECVET Seminar for the Nuclear Energy Sector

12th - 14th November 2014
Hotel Nord Nuova Roma, Rome (IT)



| NUC-VET CS pilot project | |
|---|---|
| 3 rd ECVET Seminar participation | Selected Participants: 16 |
| | ✓ 10 countries represented |
| | ✓ 3 European Networks: EFTS projects-ENEN, Petrus III, ENETRAP III |
| | ✓ 7 National Networks: Romania (2), Spain, Bulgaria (2), Italy (2), Germany, Austria |

| | | | | | | |
|----|----|----|----|----|----|----|
| RO | BG | DE | IT | ES | ES | AT |
| 11 | 7 | 6 | 4 | 3 | 1 | 1 |



3. The NUC-VET pilot project outline



Key elements of a PP (defined by existing ECVET PP):

- a) **Partnership/ Project consortium**
- b) **Project structure**
- c) **PP-test ECVET in the context of Mobility of individual learners**

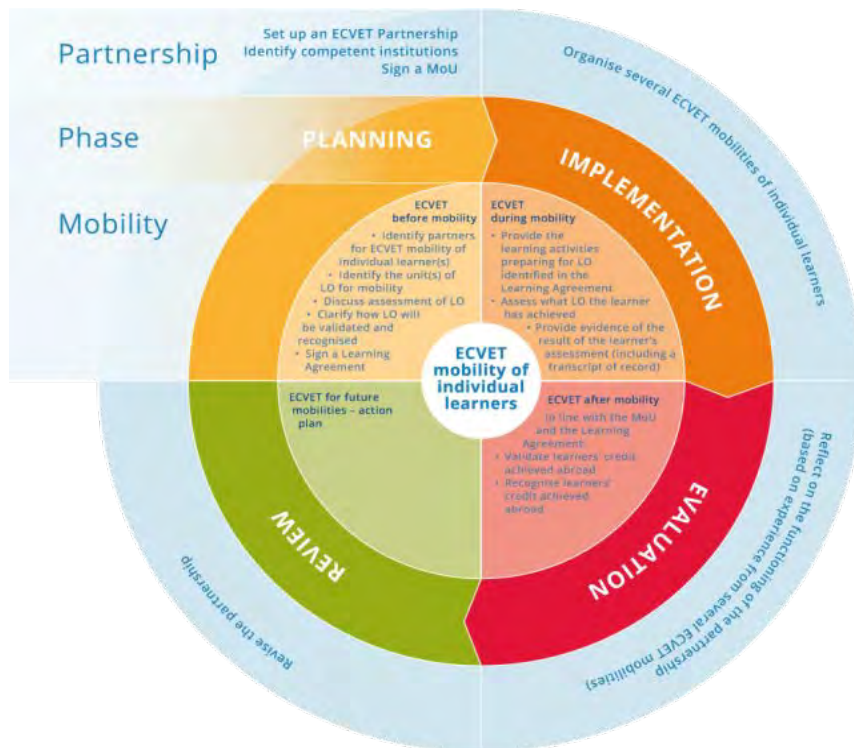

NUClear-VET pilot project/NUC-VET PP

The ideal structure of NATIONAL NUC-VET network:

a) **Partnership/
The project consortium**

- ✓ **Industry: NPP, RadWaste facility, other type of nuclear facilities**
- ✓ **National Administration (competent for qualification accreditation)**
- ✓ **Regulatory body – TSO**
- ✓ **E&T providers**



b) The NUC-VET PP structure

NUC-VET pilot project

set out in four phases; lasts 3 years

Preliminary phase (1): selecting one or more professions to be “nuclearized”

Preparation phase (2): agreeing on the specific learning outcomes to be gained during the learning period abroad

Implementation phase (3): learning period abroad

Final phase (4): assessment and recognition of the learning outcomes achieved abroad



NUC-VET pilot project

The Case study is an example on how would be approached the Preliminary phase (1) of the NUC-VET PP

Preliminary phase (1): selecting one or more professions to be "nuclearized"

"Nuclearization" major HR process

Case study: **TPP operator** → profession to be "nuclearized"
→ NPP CRO → upgraded at Shift Supervisor/ SS

Methodological issues → raised by "nuclearization" process?
"nuclearization" = upgrading of a non-nuclear qualification to a nuclear qualification

Remark: Each pilot project would select other profession for " nuclearization" or updating



4. Methodological aspects

4.2 Problems raised by the "nuclearization" process



Case study: TPP operator → profession to be "nuclearized" → NPP CRO → upgraded at Shift Supervisor/ SS

| TPP Operator | NPP-CRO | Shift Supervisor |
|--------------------------|----------------------------|--|
| Secondary studies/EQF4-5 | Secondary studies/ EQF 5 | <ul style="list-style-type: none"> • Tertiary studies / EQF 6 • at list one CRO license exten. |
| | Licensed by NPP management | Licensed by national nuclear regulatory body |

Methodological aspects

| | |
|--|--|
| <p>The upgrade from TPP operator to NPP-CRO</p> <p>→ same prerequisite EQF 5; no barrier</p> <p>→ acquiring the nuclear K,S,C/A according to NPP-CRO JD_2.2.02 (Input 1)</p> | <p>The upgrade from NPP-CRO to SS</p> <p>→ different initial requirements</p> <p>→ in the KB-QS different prerequisite → barrier</p> <p>→ in the CB-QS → pathways between VET & higher edu. (competences → in any Learn. Syst)</p> <p>→ upgrade CRO to Shift Supervisor rise 2 problems</p> <p>a) "invent/develo" pathways between VET/EQF 5 & higher edu./EQF 6 → PP consortium structure</p> <p>b) "invent/develop" methods of validation & recognition of K,S,C acquired by NA & IL</p> |
|--|--|



Euratom Training and Education activities within Horizon 2020 and Collaboration possibilities with the European Commission



A. Bucalossi
JRC A.04 Nuclear Safety and Security
Coordination

andrea.bucalossi@ec.europa.eu

3rd ECVET Seminar for the Nuclear Energy Sector
Rome, 12/11/2014



Index

Education and Training - General

European Commission

Joint Research Centre

Other Commission Linked Initiatives

Training and Education

Funding

Symposium

SET plan

Erasmus +

Marie Curie

Information from the other Commission Services (ENER,)

ENEN



Education and Training

International consensus on an urgent need to promote International Nuclear training and education activities in the nuclear field



“International and national Education and Training (E&T) activities in the nuclear field are urgently needed in order to ensure the development and maintenance of safe and secure nuclear energy.....” -

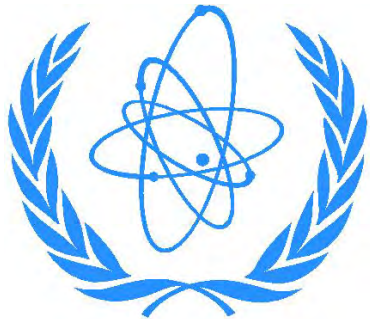

*“As the nuclear workforce ages and retires, and support decreases for university programmes in nuclear science and engineering, **knowledge management is becoming critical to ensuring safety and security**, encouraging innovation, and making certain that the benefits of nuclear energy - ... - remain available for future generations.” - Mr. M. El Baradei, Director General of the IAEA, 2000*



*The Nuclear Energy Agency (OECD/NEA) study in 2000, “Nuclear Education and Training...Cause for Concern”, highlighted the **necessity for a renaissance in nuclear education and training***



- **Euratom Treaty, Art. 33**

- Each MS “shall take the necessary measures with regard to teaching, education and vocational training”

*European Nuclear Energy Forum identified the **nuclear education as one of highest risks** in nuclear industry*

COMMUNICATION FROM THE COMMISSION TO THE EUROPEAN PARLIAMENT AND THE COUNCIL – 2nd SITUATION REPORT ON EDUCATION AND TRAINING IN THE NUCLEAR ENERGY FIELD IN THE EUROPEAN UNION



Nuclear Stakeholders

Nuclear Systems suppliers (e.g. nuclear vendors, engineering companies, manufacturers)

Energy providers (electrical utilities)

Nuclear regulatory bodies and associated TSO

Higher education and training institutions (universities)

Research organizations (e.g. public and private sectors, industrial and medical)

Civil society (policy makers and opinion leaders), interest groups and NGOs.



Risks

Shortage of of Competence (Aging of personnel, retirements)

Risk of loss of valuable knowledge

Degradation in technology skills and know-how

Possible degradation in safety of current installations

Dilution or loss of innovation potential

Reduced Research and Development



ONE MUTUAL RECOGNITION SYSTEM ACROSS THE EUROPEAN UNION

“European Credit system for Vocational Education and Training” (ECVET): adopted by the EP and Council of 18 June 2009

European instrument aimed at:

- **promoting mutual trust and mobility** in vocational education and training
facilitating the transfer, recognition and accumulation of assessed learning outcomes of individuals during periods of mobility on their way to achieving a qualification The **adoption** and implementation of ECVET in the participating countries **is voluntary**.

Participating Countries and the Commission are supporting a Europe-wide testing of this instrument with all stakeholders being invited to participate (task of DG EAC).



ECVET is based on:

*Learning outcomes are statements of what a learner knows, understands and is able to do on completion of a learning process, **defined in terms of knowledge, skills and competence** – a variety of education and training paths are possible (be they in a formal, non-formal or informal context)*

*Units of learning outcomes that are components of qualifications. **Units can be assessed, validated and recognised***



*Credit that is given for assessed and documented learning outcomes of a learner. **Credit can be transferred** to other contexts and accumulated to achieve a qualification on the basis of the qualifications standards and regulations existing in the participating countries*

***Mutual trust and partnership** among participating organisations. These are expressed in **Memoranda of Understanding** and Learning Agreements*

***Europass** (or Europass Certificate Supplement), which describes the qualifications and the achieved credit of each single learner.*



European Commission



Panorama of the European Union

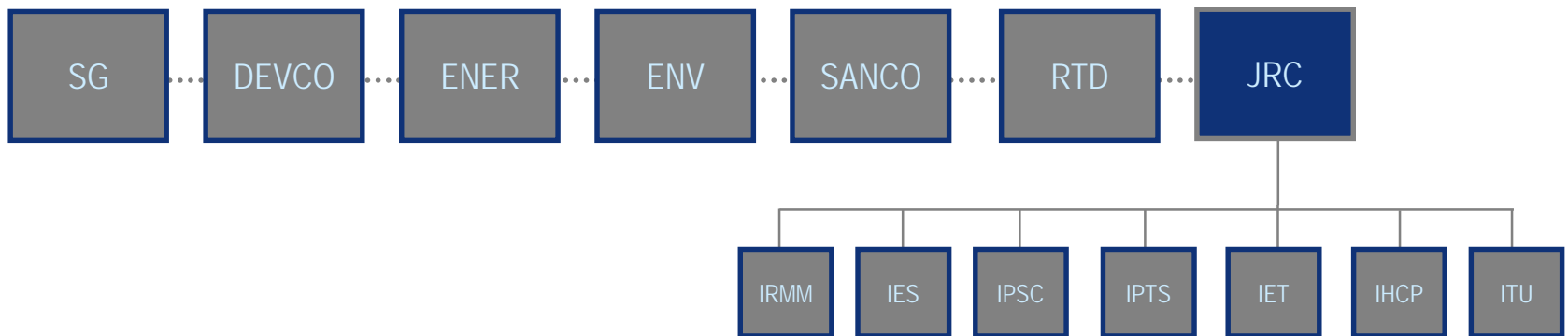

Juncker Commission



European
Commission

PRESIDENT
JEAN-CLAUDE JUNCKER

First Vice-President

Frans Timmermans
*Better Regulation,
Interinstitutional Relations,
Rule of Law & Charter of
Fundamental Rights*

High Representative

Federica Mogherini
*High Representative of the Union
for Foreign Policy & Security
Policy/Vice-President*

Vice-President

Kristalina Georgieva

Budget & Human Resources

Vice-President

Andrus Ansip

Digital Single Market

Vice-President

Maroš Šefčovič

Energy Union

Vice-President

Jyrki Katainen

*Jobs, Growth, Investment
& Competitiveness*

Vice-President

Valdis Dombrovskis

*The Euro
& Social Dialogue*

Commissioner

Věra Jourová

*Justice, Consumers
& Gender Equality*

Commissioner

Günther Oettinger

Digital Economy & Society

Commissioner

Pierre Moscovici

*Economic & Financial Affairs,
Taxation & Customs*

Commissioner

Marianne Thyssen

*Employment, Social Affairs,
Skills & Labour Mobility*

Commissioner

Corina Crețu

Regional Policy

Commissioner

Johannes Hahn

*European Neighbourhood Policy
& Enlargement Negotiations**

Commissioner

Dimitris Avramopoulos

*Migration, Home Affairs
& Citizenship*

Commissioner

Vytenis Andriukaitis

Health & Food Safety

Commissioner

Jonathan Hill

*Financial Stability,
Financial Services &
Capital Markets Union*

Commissioner

Elżbieta Bienkowska

*Internal Market, Industry,
Entrepreneurship & SMEs*

Commissioner

Miguel Arias Cañete

Climate Action & Energy

Commissioner

Neven Mimica

*International Cooperation
& Development*

Commissioner

Margrethe Vestager

Competition

Commissioner

Violeta Bulc

Transport

Commissioner

Cecilia Malmström

Trade

Commissioner

Karmenu Vella

*Environment, Maritime
& Fisheries*

Commissioner

Tibor Navrácsics
*Education, Culture,
Youth & Sport*

Commissioner

Carlos Moedas
*Research, Science
& Innovation*

Commissioner

Phil Hogan

*Agriculture
& Rural Development*

Commissioner

Christos Stylianides

*Humanitarian Aid
& Crisis Management*

EAC + JRC

RTD

CLIMA + ENER

**The HRVP may ask this
Commissioner (and other
Commissioners) to deputise
for her in areas related to
Commission competence.*



EURATOM Structure

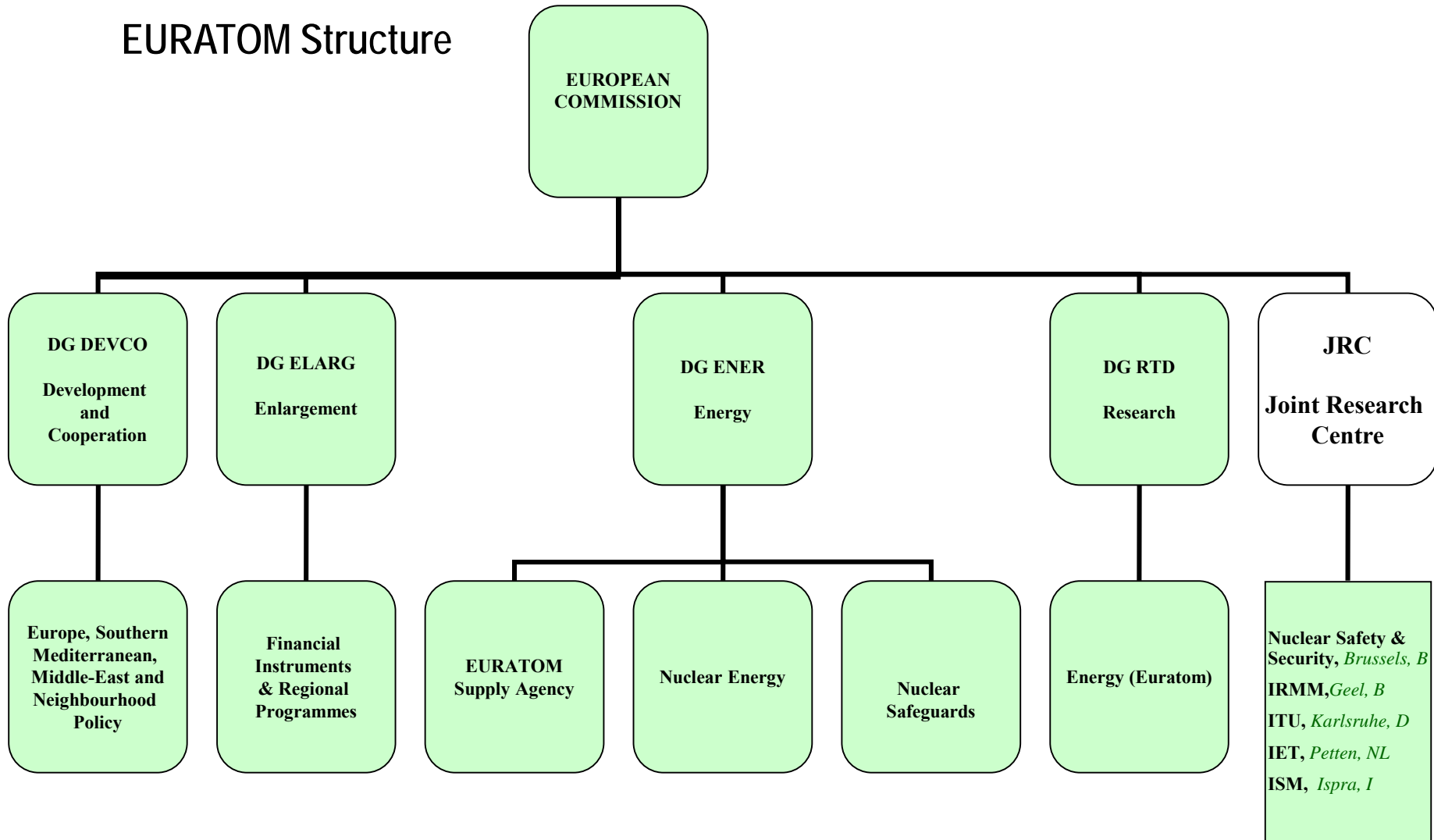



Joint Research Centre

JRC at a glance



- Established 1957
- **7 institutes** in **6 locations**
- **3014 staff** in January 2014
- **1388 scientific publications** in 2013
- Budget: **€393 million** annually, plus **€73 million** earned income

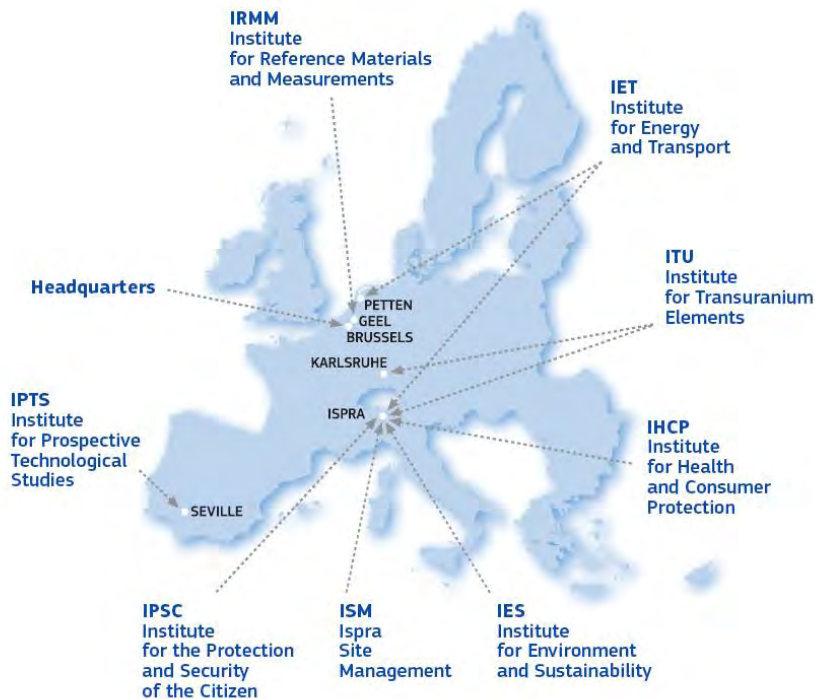

JRC's structure

JRC Institutes

- **IRMM** – *Geel, Belgium*
Institute for Reference Materials and Measurements
- **ITU** – *Karlsruhe, Germany, and Ispra, Italy*
Institute for Transuranium Elements
- **IET** – *Petten, The Netherlands, and Ispra, Italy*
Institute for Energy and Transport
- **IPSC** – *Ispra, Italy*
Institute for the Protection and Security of the Citizen
- **IES** – *Ispra, Italy*
Institute for Environment and Sustainability
- **IHCP** – *Ispra, Italy*
Institute for Health and Consumer Protection
- **IPTS** – *Seville, Spain*
Institute for Prospective Technological Studies



Legal Basis

JRC mandate: *The Joint Research Centre (JRC) will provide independent customer driven scientific and technological support for the formulation, development, implementation and monitoring of Community **policies**, in particular in the field of nuclear safety and security **research** and training.*

*The current nuclear **research** activities of the JRC are defined in the **Euratom Treaty** as well as in the recently adopted "Council Regulation on the **research and training** programme of the European Atomic Energy Community (2014-18) complementing **Horizon 2020**"*



Euratom Programme (2014-2018) complementary to the Horizon 2020

→ Council Decision on 16 December 2013

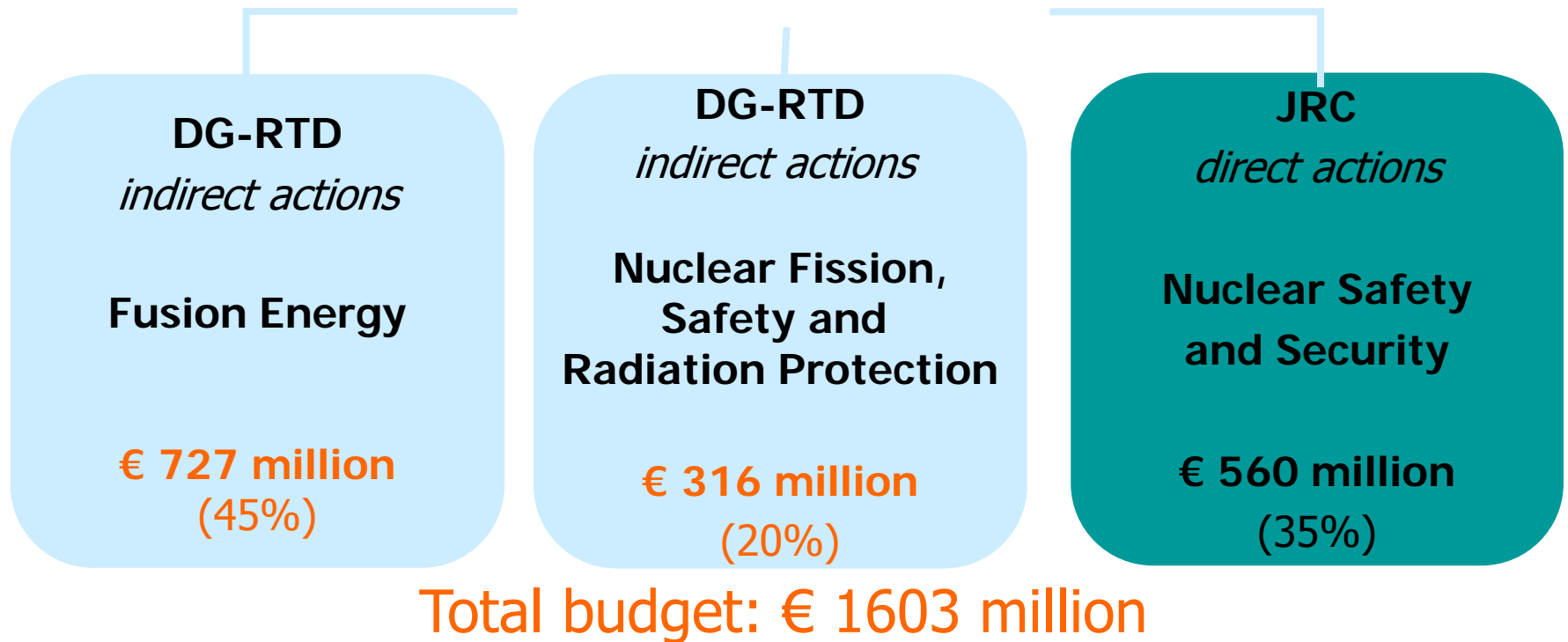

ITER (2014-2020): € 2915 million in current values (outside H2020)

→ Council Decision on 13 December 2013

JRC key orientations in Ho2020 (1/2)

(a) Improve **nuclear safety** including: fuel and reactor safety, waste management and decommissioning, and emergency preparedness

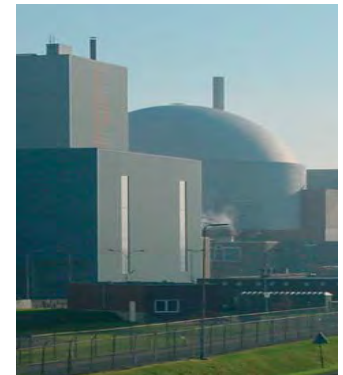

(b) Improve **nuclear security** including: nuclear safeguards, non-proliferation, combating illicit trafficking, and nuclear forensics



JRC key orientations in Ho2020 (2/2)

(c) Raising Excellence in the nuclear science base for **standardisation**

(d) Foster knowledge management, **education and training**

(e) Support the **policy** of the Union on nuclear safety and security and the related evolving Union legislation



1. Nuclear reactor safety

EU

- *Follow up of stress tests implementation*
- *Reinforcement of the EU Clearinghouse on NPP operational experience;*
- *Scientific support to the implementation of the EURATOM Treaty (Art.41-43) and to the Nuclear Safety Directive*
- *Support the implementation of the EU Nuclear Safety Directive (2014)*

Non-EU

- *Support the improvement of nuclear safety outside the EU (e.g DEVCO), including through the IAEA Action Plan on Nuclear Safety*



2. Accident Management and Emergency preparedness & response

Post Fukushima: strengthen the capacity to respond to nuclear accidents and incidents by

- *Further integrated investigation of nuclear SA phenomenology*
- *Improved mitigation mechanisms*
- *Development of models for source term, accident progression and radiological dispersion; radioactivity measurements; and environmental monitoring tools*
- *Training and Education*

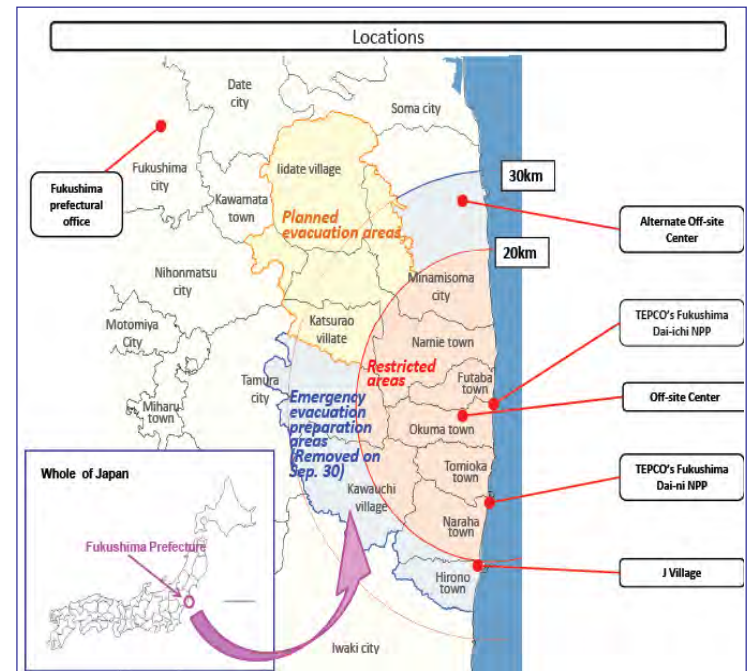

Fukushima accident overview

3. Nuclear fuel & fuel cycle safety

- *Assessment of safety limits of nuclear fuel behaviour in normal, transient and accident conditions*
- *Safety of advanced fuels (Gen IV)*
- *Advanced partitioning*
- *Spent fuel/ spent fuel storage safety/ long term operation of spent fuel storages*
- *Training and Education*

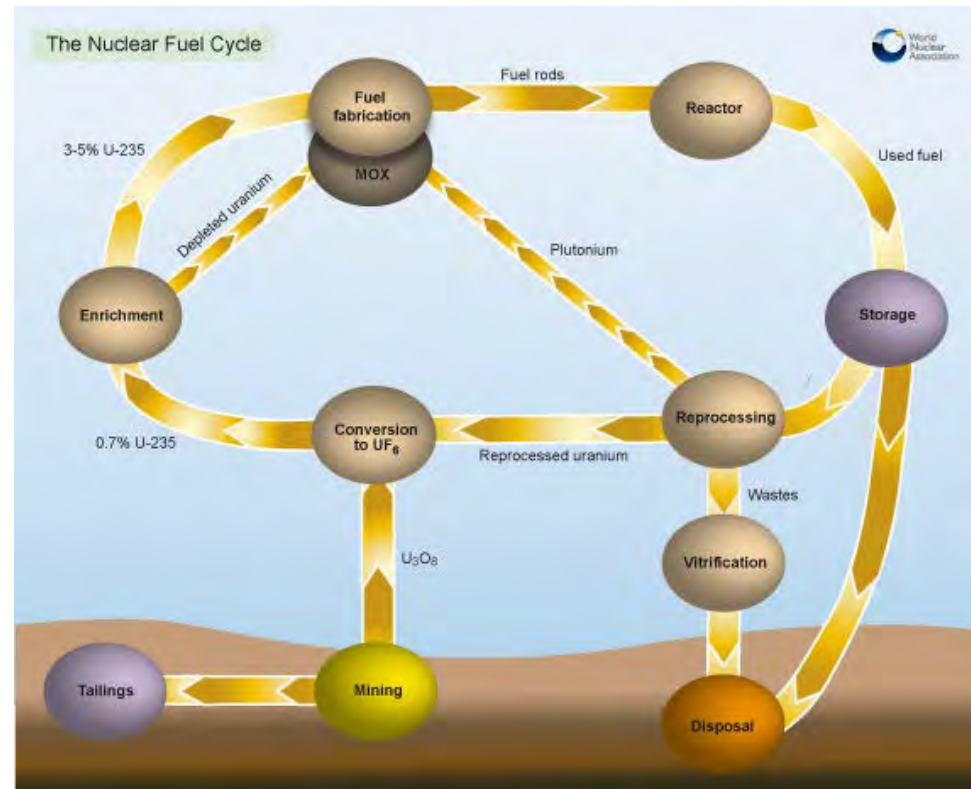

Nuclear fuel cycle

4. Waste management & decommissioning

- *Support the implementation of the EU Directive on spent fuel and waste management (2011)*
- *Minimise scientific uncertainties in alteration/corrosion mechanisms*
- *Develop EU research: waste reduction techniques, contamination, characterisation and waste qualifications*
- *Training and Education*
- *harmonisation and standardisation of technologies*



Real scale test of the Roman Pit excavation (Ispra, Italy)

5. Nuclear safeguards, non-proliferation & security

- *Technologies, methodologies, Reference Materials, applied for **Safeguards** and IAEA Additional Protocol*
- *Export Control, **Non-proliferation Analysis** based on open source information*
- *Development and application of enhanced methods and technologies to prevent, detect and respond to nuclear and radioactive material misuse*
- **CBRN** (Chemical, Biological, Radiological, Nuclear) security within and outside the EU
 1. **EU CBRN Action Plan**: strengthen CBRN security in the EU
 2. **Non-EU**: CBRN risk mitigation and preparedness: Centres of Excellence initiative/technical support to DG DEVCO actions



Training and Education



- Higher Academic Training (Courses in Universities, PhD opportunities)
- Vocational Training (Dedicated training courses for professionals)
- User Facility (Access to JRC Nuclear Facilities – EUFRAT, ACTILAB)





Key Areas for Vocational Training in JRC

- Nuclear Safeguards, Security and Forensics
- Nuclear Fuel Cycle, with emphasis on nuclear fuel and fuel processing
- Basic Nuclear Science : nuclear data, physics and chemistry of the actinides

Competences of JRC that are unique or strongly complementary to those of the academic institutions

Nuclear data, Standards
Reference materials and measurements

Monitoring of radioactivity
in the environment

- Nuclear safeguards, non-proliferation
- Combating illicit trafficking

- Nuclear waste management and environmental impact:
- Spent fuel characterisation
- Partitioning, transmutation, conditioning
- Safety of present and advanced nuclear fuel systems

- Proliferation Resistance and Safeguards R&D
- Border monitoring (detection) and Open source information

irm
Institute for Reference
Materials and Measurements

- Safety of nuclear installations
- Advanced nuclear energy systems

ie
Institute for Energy

European
Human Resources
Observatory

itu
Institute for
Transurium
Elements

- Cross-cutting activities:*
- Actinide sciences
 - Education and Training / Networking
 - Medical Applications



EUSECTRA Training Courses

- Front Line Officers
- Trainers/future trainers
- Experts
- Management/Decision Makers
- Safeguard inspectors

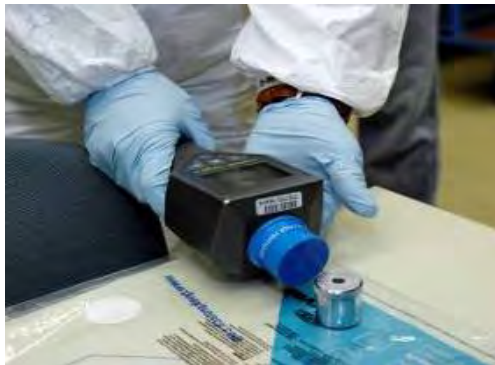

External Training Area

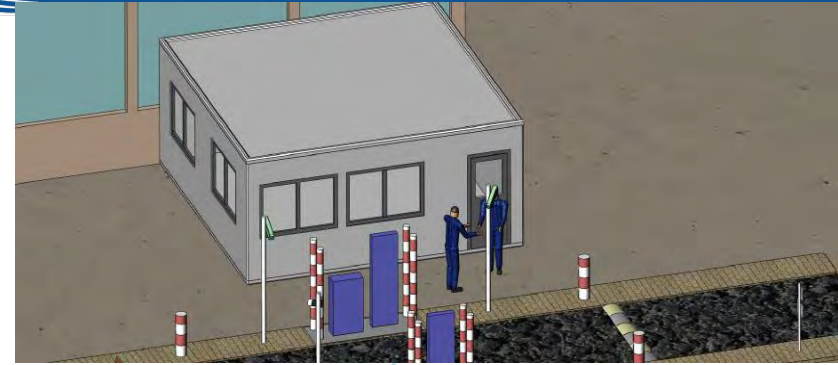
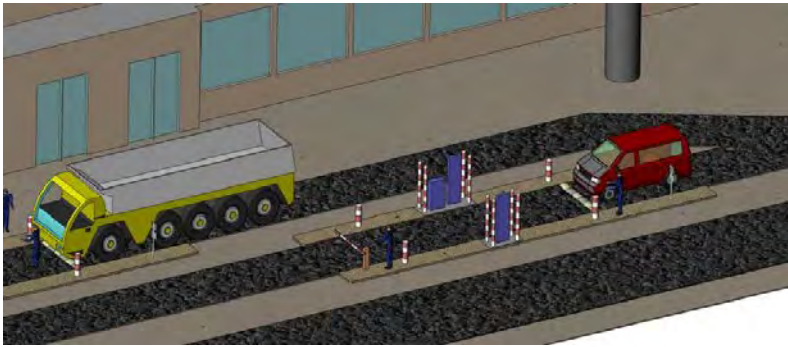

TSA from SLD

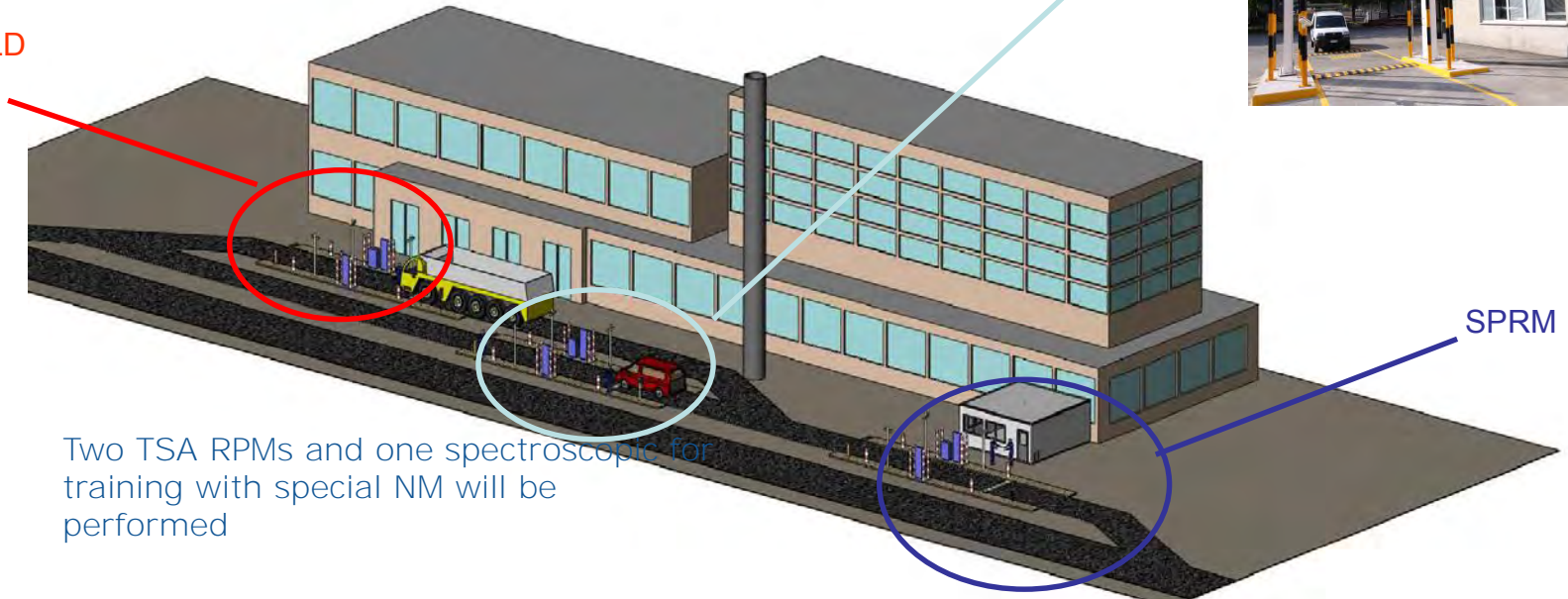

Two TSA RPMs and one spectroscopic for training with special NM will be performed

Implementation of JRC Euratom Programme IRMM / Facilities and equipment



GELINA

Van de Graaff



Two accelerator-based neutron data facilities

Laboratories for the preparation of nuclear reference materials

Radionuclide measurement laboratories

Underground low-level radioactivity laboratory

- gamma-ray spectrometry with detection limits of the order of mBq/kg

- **Nuclear data for safety of reactors and radioactive waste management**
- **Basic Research in Nuclear Physics and Nuclear Data Standards**
- **Radionuclide metrology for primary standardisation and EU policy support**
- **Metrological tools to support nuclear safeguards activities**

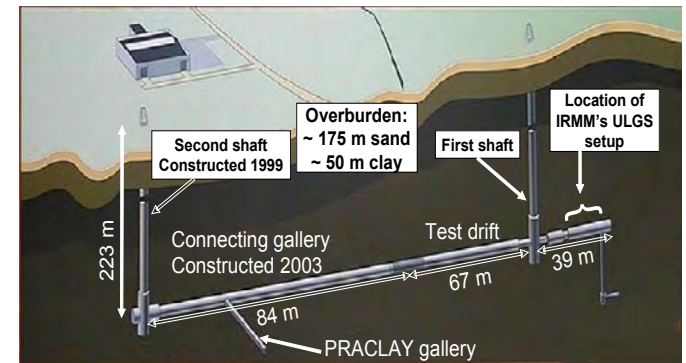



HFR

Reactor operated by NRG (NL) –On-going activity

- **Research neutron standardization techniques**
- **Safety of reactors and fuels (Minor Actinide Recycling, HTR fuels)**
- **Materials for Gen III and IV thermal and fast reactors (integrity of : pins, Graphite – AGR, steels + welds)**
- **Materials for fusion reactors (shielding blanket in ITER)**

JRC Activities on structural materials

- **Physics-based material models (relate microstructure => global material properties)**
- **Test techniques: small punch test, very high high-cycle fatigue**
- **Environmental assisted degradation in nuclear components.**
- **Knowledge management and data bases**



AMALIA lab

Implementation of JRC Euratom Programme JRC-ITU/Facilities and equipment



Solid state NMR



Hot cells (24)

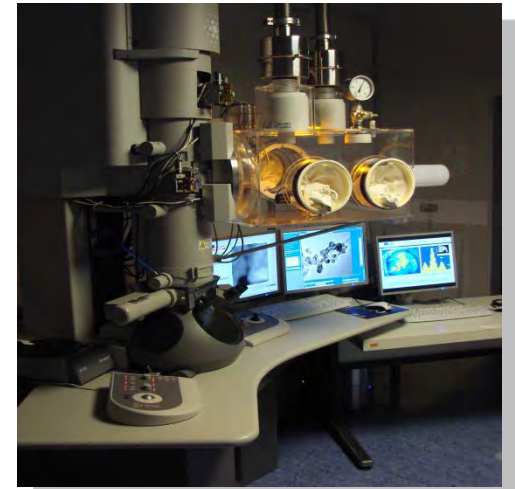

Transmission electron
microscopy



Surface science



Large geometry secondary ion
mass spectrometry (SIMS)



Minor Actinide laboratory



Other Commission Linked Activities



Strategic framework – Education & Training 2020

Each EU country is responsible for its own education and training systems

*EU policy is designed to support national action and help address **common challenges**, such as*

- **ageing societies,**
- **skills deficits in the workforce,**
- **global competition.**



Strategic framework – Education & Training 2020

The EU offers a forum for exchange of best practices, gathering and dissemination of information and statistics, as well as advice and support for policy reforms.

Funding is available for activities that promote learning and education at all levels and for all age groups.



Strategic framework – Education & Training 2020

EU countries have identified four common objectives to address these challenges by 2020:

- Making **lifelong learning** and mobility a reality;
- Improving the **quality and efficiency** of education and training;
- Promoting **equity, social cohesion, and active citizenship**;
- Enhancing **creativity and innovation**, including entrepreneurship, at all levels of education and training.



European Research Area

Low-carbon strategy for 2050

Targets compared to 1990 levels



Source: European Commission

BACKGROUND OF EURATOM WP 2014-2015

WP 2013 – Transition towards HORIZON 2020

- Focus on preparatory actions towards joint programming

Interdisciplinary Study on "Benefits and limitations of nuclear fission for a low-carbon economy" (2012) & Symposium (2013)

- Safety / Safety culture
- Socio-economics in the overall energy mix
- Civil society
- Education and training

HORIZON 2020 main orientations

- Challenge oriented
- Emphasis on impact





~ €15M

Geological disposal

ETPs



~ €45M

Reactor systems

- Safety of existing nuclear installation
- Advanced nuclear systems for increased safety
- Transmutation
- Cross-cutting aspects



~ €20M

Radiation protection



~ €30M

**Research infrastructures
Training and mobility
Cross-cutting**

**Grand Total 2014-2015:
~ 110 M€**

<http://ec.europa.eu/research/participants/portal/desktop/en/opportunities/h2020/calls/nfrp-2014-2015.html>

H2020 Energy Information Day Agenda, Info, Web streaming
http://ec.europa.eu/research/conferences/2013/energy_infoday/infoday_energy_en.htm



64 proposals...

Total Costs 376 Mi€
EC Requested 227Mi€

Evaluations launched and being finalised

| Event | Date |
|---|-------------------------|
| Adoption Legislative Act | 11/12 |
| Publication | 11/12 |
| Deadline | 17/09 |
| Evaluations | 29/09/2014 – 24/10/2014 |
| Negotiations | 1/12/2014 – 28/02/2015 |
| Deadline NFRP16 (VVER Fuel licensing) | 20/11/2014 @ 17:00 |
| Grant Agreement signature..... | 02/2015 |
| First projects launched | 02/2015 |

EU funding opportunities and legal status options



| Funding opportunity / Legal option | Applicable |
|---|--|
| ERIC European Research Infrastructure Consortium legal framework | NO |
| Joint Undertaking legal framework (Euratom) | Yes |
| International non-profit Association (AISBL)..... | Yes |
| Euratom loans for the research facilities | Yes, art.41 Euratom treaty |
| EIB Risk Sharing Financial Facility RSFF-II | Yes, Euratom contribution ... within Call 2016 ? |
| Cohesion Policy and EU Development Regional Funds | Yes, at MS initiatives and within Smart Specialisation |
| EU Grants through H2020 competitive calls •H2020 Euratom Fission work programme •H2020 EU/Euratom cross-cutting programmes: European Research Council (ERC), Fusion, Marie Curie actions, Knowledge Innovation Centre (KIC)... | Yes, ERC Yes, Marie-Curie Yes, Teaming and twinning (Spreading excellence and widening participation) |

Potential



... At EU level

YES
16 Bi€

Education, Audiovisual and Culture Executive Agency (EACEA)



Programmes managed by the EACEA:

Lifelong learning

Erasmus Mundus

Tempus

Bilateral cooperation

Intra-ACP academic mobility scheme



- Eligible countries for Lifelong learning
- Eligible "third" countries for the Jean Monnet programme

- Eligible countries for Erasmus Mundus

- EU members states
- Tempus Partner Countries

- Countries involved in a cooperation

- Eligible countries for the intra-ACP academic mobility scheme



YES
6 Bi€
65000 PhDs



YES
13 Bi€

YES
2.7 Bi€



The European Group on Ethics in Science and New Technologies: Opinion No. 27
An ethical framework for assessing research, production and use of energy
Brussels, 16 January 2013

On January 16, 2013, the EGE adopted Opinion 27 an "**Ethical framework for assessing research, production, and use of Energy**". The EGE recommends to achieve equilibrium between four criteria - **access rights, security of supply, safety, and sustainability** - in light of **social, environmental and economic concerns**.

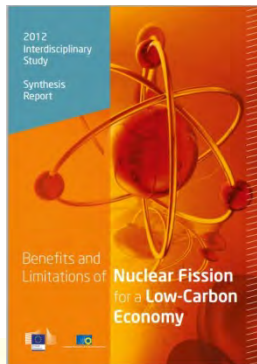

*Nuclear Fission Symposium website
<http://www.eesc.europa.eu/?i=portal.en.events-and-activities-symposium-on-nuclear-fission>*



10-Apr-13



JRC SCIENCE AND POLICY REPORTS

Strategic Energy Technology (SET) Plan Roadmap on Education and Training

*Availability and mobilisation of
appropriately skilled human
resources*

JRC Coordinators: A. Georgakaki, U. von Estorff,
S.D. Petevs
2014



'SETPLAN Education and Training roadmap' and technology experts' assessments has been published on the SETPLAN Information System (SETIS)

<http://setis.ec.europa.eu/setis-deliverables/education-training-roadmap>

SETPLAN ERKC

Energy Research Knowledge Centre collects and organises validated, referenced information on energy research programmes and projects

<http://setis.ec.europa.eu/energy-research/>



ERKC
Energy Research Knowledge Centre

Energy Research Knowledge Centre (ERKC), a unique information resource on energy research across Europe.

- **Communication COM(2015)xxxx** early having 10-20 "cover" pages (methodology and executive summary) and
- **Annex Staff Working Document (SWD)** containing 4 consolidated parts



COM(2015)

10 – 20
"cover"
pages

I. Energy Efficiency

II. Competitive, Efficient,
Secure, Sustainable and
Flexible Energy System

III. Cities, Communities and
Market Uptake

IV. Cross Cutting Issues



Integrated Challenge 1: ACTIVE CONSUMER AT THE CENTRE OF THE ENERGY SYSTEM

THEME 1:
Empowering consumers to become active players in the energy system

THEME 2:
Enabling consumers to manage their energy demand and become actively part of the energy supply

Integrated Challenge 2: DEMAND FOCUS – INCREASING ENERGY EFFICIENCY ACROSS THE ENERGY SYSTEM

THEME 3:
Increasing energy efficiency in buildings

THEME 4:
Increasing energy efficiency in heating and cooling

THEME 5:
Increasing energy efficiency in industry and services

THEME 6:
Innovative financing for energy efficiency

Integrated Challenge 3: SYSTEM OPTIMISATION

THEME 7:
Modernising the European electricity grid and establishing synergies between the various energy networks

THEME 8:
Unlocking the potential of energy storage and hydrogen

THEME 9:
Providing the energy system with flexibility, demand response, security and cost-effectiveness

THEME 10:
Development and demonstration of holistic system optimisation at local/urban level (Smart Cities and Communities)

Integrated Challenge 4: SECURE, COST-EFFECTIVE, CLEAN AND COMPETITIVE SUPPLY

THEME 11:
Accelerating the development of renewable electricity and heating/cooling technologies

THEME 12:
Enabling carbon capture, utilisation and storage technologies and increased efficiency of the fossil fuel-based power sector and energy intensive industry

THEME 13:
Supporting safe operation of nuclear systems and development of sustainable solutions for the management of radioactive waste

THEME 14:
Developing sustainable biofuels, fuel cells and hydrogen and alternative fuels for the European transport fuel mix

THEME 15:
Innovative financing for energy supply

Integrated Challenge 5: CROSS-CUTTING SOCIAL, ENVIRONMENTAL AND ECONOMIC ASPECTS AND INTERNATIONAL COOPERATION

THEME 16:
Education

THEME 17:
International cooperation

THEME 18:
Socioeconomics in support of policymaking



| Event | Date |
|--|--|
| Communication on Energy Technologies and Innovation COM(2013) 253 final ... | 02/05/2013 |
| Set up Coordination and Working Groups | 15/07/2013 |
| Kick-off meeting..... | 17/09/2013 |
| Dedicated WG hearings and 1 st drafts | 01/10 – 30/04/2014 |
| Member States, Steering Group and WG comments Draft | 30/10/2015 |
| Final Draft, Steering Group and SET-Plan Conference (Rome 10-11 December 2014) | 10-11/12/2014 http://www.setplan2014.it/ |
| SET-Plan Integrated roadmap publication | 1 st Quarter 2015 |

SET-Plan as the core strategy to deliver on the energy challenge, to respond to the new challenges such as system integration, industrial leadership, new and emerging technologies and to better consolidate R&I capacity and resources across Europe ...

http://ec.europa.eu/energy/technology/strategy/doc/comm_2013_0253_en.pdf

SET-Plan Conference



HOME ABOUT CONFERENCE VIDEO MEDIA PRACTICAL CONTACT US PARTICIPANT AREA

A panoramic view of Rome, Italy, showing the Auditorium Antonianum and other historical buildings under a blue sky with mountains in the background.

SET Plan Conference 2014

Driving the energy transition together

[REGISTER NOW](#)

WHEN
10-11 December
Starting Time: 09:00 AM

WHERE
Rome, Italy
Auditorium Antonianum

10-11 December 2014 in Rome at Auditorium Antonianum

Website <http://www.setplan2014.it/>



ERASMUS+

EU programme for education, training, youth and sport

European Commission > Programmes > Erasmus+



Discover Erasmus+ Funding opportunities Partners, Portals, & Tools

Changing lives, opening minds

The Erasmus+ Programme Guide for the 2015 General Call for Proposals was published in English on 06/10/2014, with further language versions to follow at the end of October.

The Programme Guide provides detailed conditions for participating in the call for proposals, as well as information on the priorities for funding. It constitutes an integral part of the call for proposals.

NEW ERASMUS+ CALL AND PROGRAMME GUIDE



In a nutshell

Erasmus+
New EU programme for education, training, youth and sport



Erasmus+ @EUERasmusPlus
Announcing a new set of minicontests, #ErasmusPlusFavs! Learn more & tell us your favorite food to win a T shirt: on.fb.me/1yhqZWW

Erasmus+ @EUERasmusPlus
There are all kinds of ways to tell #Stories. Get inspired and learn how you can win a €200 by telling us yours: on.fb.me/1wXRQjd

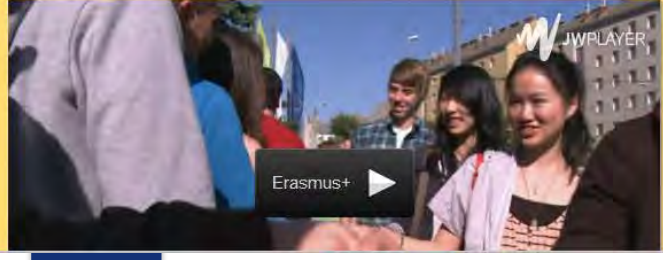



Erasmus+ is the EU Programme in the fields of education, training, youth and sport for the period 2014-2020 => to support the implementation of the Europe 2020 strategy for growth, jobs, social equity and inclusion.

Erasmus+ is the result of the integration of the following (2007-2013):

- **The Lifelong Learning Programme**
- **The Youth in Action Programme**
- **The Erasmus Mundus Programme**
- **Tempus**
- **Alfa**
- **EduLink**
- **Programmes of cooperation with industrialised countries in the field of higher education**

http://ec.europa.eu/programmes/erasmus-plus/index_en.htm



Erasmus+ who benefits?

- 2 million higher education students will be able to study or train abroad, including 450,000 traineeships;*
- 650 000 vocational students and apprentices will receive grants to study, train or work abroad;*
- 800 000 school teachers, lecturers, trainers, education staff and youth workers to teach or train abroad;*
- 200 000 Master's degree students doing a full course in another country will benefit from loan guarantees;*
- More than 500 000 young people will be able to volunteer abroad or participate in youth exchanges;*



- *More than 25 000 students will receive grants for joint master's degrees, which involve studying in at least two higher education institutions abroad;*
- *125 000 schools, vocational education and training institutions, higher and adult education institutions, youth organisations and enterprises will receive funding to set up*
- *25 000 'strategic partnerships' to promote the exchange of experience and links with the world of work;*
- *3 500 education institutions and enterprises will get support to create more than 300 'Knowledge Alliances' and 'Sector Skills Alliances' to boost employability, innovation and entrepreneurship;*
- *600 partnerships in sport, including European non-profit events, will also receive funding.*

Marie Skłodowska-Curie research fellowships

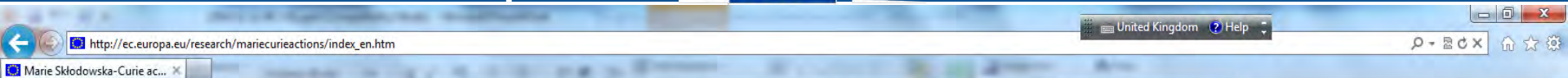

Sitemap | Legal notice | Contact | Search English (en)



RESEARCH & INNOVATION

Marie Skłodowska-Curie actions

European Commission > Research & Innovation > Marie Skłodowska-Curie Actions

- Home
- About
- Apply now
- Funded projects
- News and events
- Media library



Research and Innovation

Research and Innovation wide event Opportunities The Destination Europe forum provides information on careers and funding opportunities for researchers seeking to work in Europe. In an exciting and entertaining way, don't miss this opportunity ...

[Read more](#)

< 1 2 3 4 5 6 >

Marie Skłodowska-Curie actions - Research Fellowship Programme

The Marie Skłodowska-Curie actions, named after the double Nobel Prize winning Polish-French scientist famed for her work on radioactivity, support researchers at all stages of their careers, irrespective of nationality. Researchers working across all disciplines, from life-saving healthcare to 'blue-sky' science, are eligible for funding. The MSCA also support industrial doctorates, combining academic research study with work in companies, and other innovative training that enhances employability and career development.

In addition to generous research funding, scientists have the possibility to gain experience abroad and in the private sector, and to complete their training with competences or disciplines useful for their careers. More information about various funding schemes and requirements for applying is available below.

- Discover more about Marie Skłodowska-Curie actions fellowships
- Find the latest jobs and traineeship opportunities

Share

Open calls

- [See all open calls](#)



Participant portal



Solutions for researchers

Attractive research careers and services in Europe



MARIE CURIE ALUMNI



European IPR Helpdesk



- *Marie Curie is applicable to Euratom within H2020.*
- *Competition is high: success rate at around 15%*
- *60.000 PhD financed in the FP7 support a few hundreds from nuclear.*

Italy FP7

- Researchers funded in MC Actions 4913
(Fellowships: 3184 - Exchanged staff : 1729)
- budget awarded to IT organisations : € 280.6 M
- Number of IT organisations participating in MC Actions: 1377



Information from the other Commission Services

Nuclear Safety Directive adopted on 8 July 2014 2014/87/Euratom



The Commission has amended in 2014 the 2009 nuclear safety directive (COM/2014/87/Euratom amending COM/2009/71/Euratom). The proposal:

- introduces new EU-wide safety objectives;
- sets up a European system of peer reviews of nuclear installations;
- establishes a mechanism for developing EU-wide harmonised nuclear safety guidelines;
- strengthens the role and independence of national regulators;
- increases transparency on nuclear safety matters;
- includes new provisions for on-site emergency preparedness and response.

http://ec.europa.eu/energy/nuclear/safety/safety_en.htm



The European Council Transport, Telecommunications and Energy from March 2014 has also asked the Commission to assess European Energy security of supply issues where nuclear is also assessed and a report to be produced by June 2014.

http://www.consilium.europa.eu/ueDocs/cms_Data/docs/pressData/en/trans/141312.pdf

An update of the WP2014-2015 has been published on 23 July 2014 following the latest events in UKRAINE on the diversification of fuel supply of these plants relevant for greater independency and security of energy supply with a topic **NFRP-16-2015** on **'Supporting the licensing of Western nuclear fuel for reactors of VVER design operating in the EU'**. **Deadline: 20-11-2014 @17:00:00**
A research and Innovation action from 1 to 3 Million EURO is foreseen

<http://ec.europa.eu/research/participants/portal/desktop/en/opportunities/h2020/calls/nfrp-2014-2015-2.html>



In response to the political crisis in Ukraine, EC proposes the following key actions:

1. Immediate actions aimed at increasing the EU's capacity to overcome a major disruption during the winter 2014/2015 (**launch of energy security stress tests**)

2. Strengthening emergency/solidarity mechanisms including coordination of risk assessments and contingency plans; and protecting strategic infrastructure

3. Moderating energy demand

4. Building a well-functioning and fully integrated internal market

5. Increasing energy production in the European Union

6. Further developing energy technologies

7. Diversifying external supplies and related infrastructure

8. Improving coordination of national energy policies and speaking with one voice in external energy policy

http://ec.europa.eu/energy/security_of_supply_en.htm

http://ec.europa.eu/energy/stress_tests_en.htm

Commission approves UK state aid to build nuclear power plant



The UK can go ahead with aid for nuclear power plant, despite criticism from member states and environmental groups. The European Commission today (8 October) announced that British plans to subsidise the construction of a nuclear power plant at Hinkley Point in the south of the country do not break EU state-aid rules.

The construction costs of the Hinkley power station are estimated at £24.5 billion (around €31.2bn). It will require debt financing of £17bn (around €21.6bn) and will eventually have a capital of about £34bn (around €43bn).

The power station would be operational by 2023 with an expected lifetime of 60 years. The output of the plant would make up 7% of the UK's electricity generation.

Britain would be allowed to offer EDF a guaranteed power price for the coming 35 years, which is set at more than twice the current market rate

http://europa.eu/rapid/press-release_IP-14-1093_en.htm?locale=en



The European Commission (Directorate General for Energy) is currently assessing to what extent the situation of potential victims of a nuclear accident in Europe could be improved, within the limits of EU competence.

The present consultation therefore seeks the views of all relevant stakeholders on **the need for common rules at EU level on insurance and compensation for nuclear accidents in the EU.**

Insurance and compensation of damages caused by accidents of nuclear power plants (nuclear liability)

http://ec.europa.eu/energy/nuclear/consultations/20130718_powerplants_en.htm

2030 Climate and Energy Policies adopted on

23-24/10/2014

2030 framework for climate and energy policies



2030
FRAMEWORK FOR CLIMATE ENERGY

The framework presented by the European Commission in January 2014 seeks to drive continued progress towards a low-carbon economy.

The latest includes a proposal of **40% GHG**, an increase of the share of **renewable energy** to at least **27%**, continued improvements in **energy efficiency 27%**, reform of the EU emissions trading system, competitive, affordable and secure energy, new governance and reporting on energy prices and costs.

The EU will submit its contribution at the 2015 Global Climate Conference in Paris

http://ec.europa.eu/clima/policies/2030/index_en.htm

http://www.consilium.europa.eu/uedocs/cms_data/docs/pressdata/en/ec/145397.pdf



ENEN

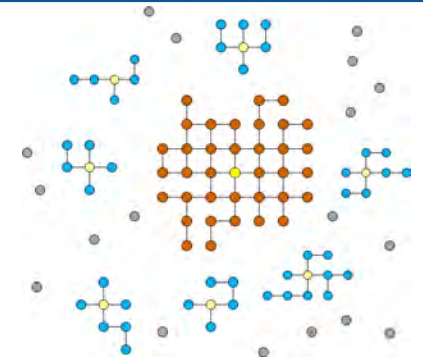

The ENEN Association

(European Nuclear Education Network)

Mission

The preservation and further development of higher nuclear education and expertise in all areas of nuclear fission and radiation protection (education and training)

Composition

⇒ 60 members (universities, research and industry) from 17 EU Member States, + CH

⇒ further international collaboration: external Memorandums of Understanding (e.g., with South Africa, Russia, Ukraine and Japan) and partnership agreements (e.g., with ENS, IAEA/ANENT, Canada and WNU) + special agreement with the Joint Research Centre

Website = <http://www.enen-assoc.org/>



<https://ec.europa.eu/jrc/>

http://ec.europa.eu/research/energy/euratom/index_en.cfm

<http://ec.europa.eu/programmes/horizon2020/en/how-get-funding>

<http://ec.europa.eu/programmes/horizon2020/en/2020-section/marie-sklodowska-curie-actions>

<http://www.enen-assoc.org/>



12
NOV
2014

14
NOV
2014

Rome (IT)

The 3rd ECVET Seminar
customized for nuclear energy
sector

Introduction



Education and Culture DG



ecvet

European Credit system for
Vocational Education & Training



Mihai Cozian, Ulfk Von Estorff - European Commission, Joint Research Centre,
Institute for Energy and Transport - The Netherlands

The road map for ECVET implementation in the nuclear energy sector



Mihai Cozian

As part of its support to the introduction of ECVET in the nuclear energy sector, the Institute for Energy and Transport (IT-1) of The Joint Research Centre (JRC), European Commission (EC), through the ECVET Team of the European Human Resources Observatory for the Nuclear energy sector (EHRO-N), has developed in the last two years a strategy and a road map for ECVET implementation in the nuclear energy sector.

This article describes the process that led to the JRC road map for ECVET implementation in the nuclear energy sector.

Qualifications in the Nuclear Energy Sector

The nuclear industry has certain special requirements that need to be considered when developing projects related to training, education and professional qualifications.

It is obvious that there are omnipresent safety and security aspects in any nuclear activity, and there are environmental and public opinion issues associated with energy production by atomic fission. As a result there is an extensive regulatory framework, developed over decades, which has led to a highly regulated regime for nuclear activities. The role of the national regulatory bodies leads to a great diversity of practices in relation to the supply demand and accreditation of education and training. This makes the implementation of ECVET additionally challenging.

Although transferability and comparability between ECTS and ECVET is an overall issue, it is especially relevant in the nuclear field as most qualifications are at the upper levels of the European Qualifications Framework (5 and above).

The nuclear industry is international both in relation to the regular move-

...ers and materials and for...
...al agreements that, to a...
...overn it. Moreover, safety...
...tically linked to nuclear...
...to the availability of a suffi...
...-qualified workforce...
...importance of this workforce...
...to-date and this requires...
...ing schemes alongside the...
...g that takes place once...
...its employment.

...onal nature of the industry...
...ed availability of suitable...
... expertise encourages the...
... of learners - either students...
...nals. In this context, syn...
... from mobility become not...
...ficial but essential. Con...
...ourse and on the job training...
...ing periods in different org...
...and countries is often nece...
...quiring and maintaining an...
... level of competence.

... likely demand for nuclear...
... the medium term suggests...
... be necessary to find ways of...
...g professionals who initially...
... nuclear background.

ECVET supports qualifications of the nuclear energy sector

...nally accepted that ECVET is...
... and major reform programme...
...can leave space, that has a...
... impact on the whole of the EU...
... particular on the nuclear energy...
... This is illustrated in Figure 1.

Figure 1
The impact of ECVET's implementation on the European Union



In the light of the specific requirements in the nuclear energy sector, the ECVET system can support the following improvements to the qualification system (as suggested in Figure 2):

- the shift to a competence based qualification system (CB-QS) that is more flexible;
- the CB-QS enables the accumulation of competences (or Learning Outcomes (Lo)) no matter in which

- education system or sector they are acquired or how long they take to achieve;
- the CB-QS permits flexible learning pathways: formal, non-formal; work based; lifelong learning and training abroad (this supports permeability between education systems and sectors);
- the CB-QS enables geographical mobility.

Figure 2
The features of the competence based qualification system

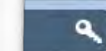

014
inar -
Riga, LV
ember)

4
usting
in the
30 - 31

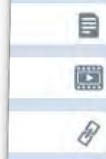

y Toolkit

Day 1 (09.00 -17.00)

Work session 1 : Analysis of possible funding

The funding schemes for nuclear ECVET projects

Work session 2: NUC-VET CREDIT SYSTEM in the EU context

Learning outcomes / units

Key concept: Qualification design in the nuclear sector

Assessment, transfer, recognition

Key concept: Mobility in ECVET

Day 2 (09.00 -17.00)

Work session 3 : Customizing the ECVET toolkit for NES

Involving stakeholders (partnerships)

ECVET Toolkit for NES

Work session 4: Sketches of pilot projects

Possible qualifications to test in an ECVET project

Day 3 (09.00 -12.00)

Work session 5 : Designing a project for NES

Activities and expected outcomes

Expected outcomes



- The seminar's main objectives are:
 - identification of the ECVET tools, necessary for a Pilot project implementation (including the financing scheme);
 - presentation of the proposal Pilot project candidatures;
 - identification of Pilot project partners (namely the NPPs or radioactive waste facilities) among the interested participants.

European educational policy



8.7.2009 EN Official Journal of the European Union C 155/11

**RECOMMENDATION OF THE EUROPEAN PARLIAMENT AND OF THE COUNCIL
of 18 June 2009
on the establishment of a European Credit System for Vocational Education and Training (ECVET)**
(Text with EEA relevance)
(2009/C 155/02)

THE EUROPEAN PARLIAMENT AND THE COUNCIL OF THE EUROPEAN UNION, (3) VET schemes, one of which are directly linked to the employment of the State. Through their implementation, not only the competitiveness and fulfilment of the social cohesion, and

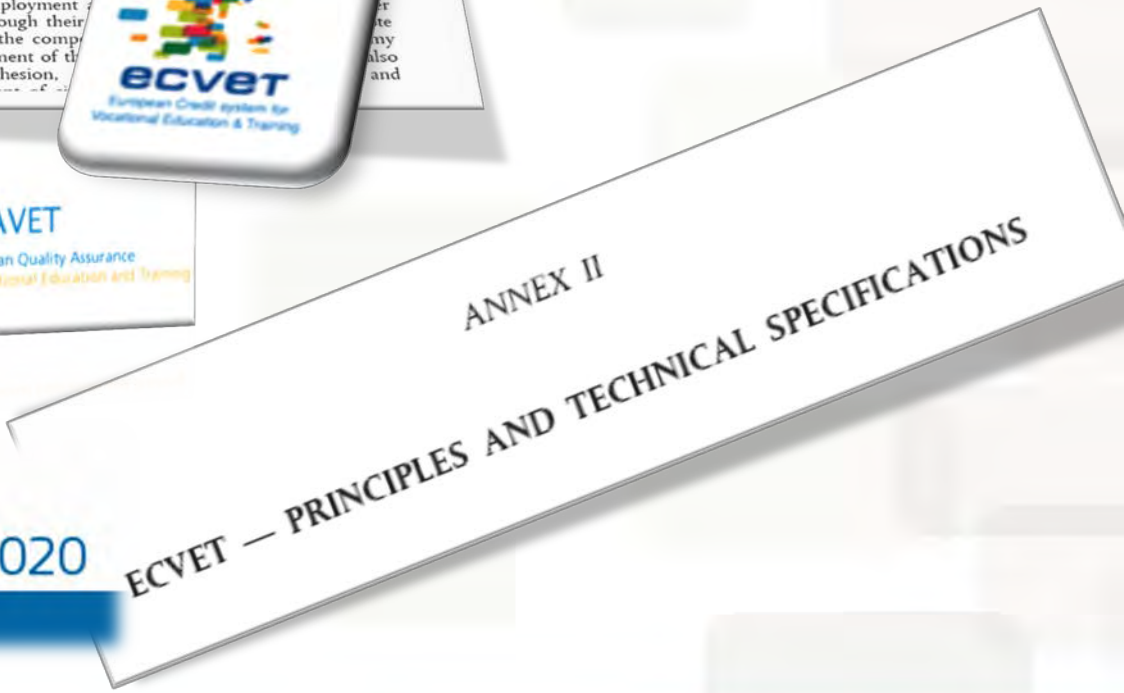

EUROPE 2020

Europe 2020 is the EU's growth strategy. We want the EU to become a **smart, sustainable and inclusive** economy.

Smart growth



Sustainable growth



Inclusive growth



Strategic framework for European cooperation in education and training ("ET 2020")

- Strategic objectives:
 - Making lifelong learning and mobility a reality;
 - Improving the quality and efficiency of education and training
 - Promoting equity, social cohesion and active citizenship
 - Enhancing creativity and innovation, including entrepreneurship, at all levels of education and training

Policy context

Copenhagen process (2002)



“The Copenhagen Declaration”
29 and 30 November 2002

**Maastricht Communiqué on the Future Priorities
of Enhanced European Cooperation in
Vocational Education and Training (VET)**
29 October 2004

**The Helsinki Communiqué (2006)
on Enhanced European Cooperation in VET
(Review of the Council conclusions of 15 November 2004)**

THE BORDEAUX COMMUNIQUÉ
November, 12 2008

RECOMMENDATION OF THE EUROPEAN PARLIAMENT AND OF THE COUNCIL
of 18 June 2009
on the establishment of a European Credit System for Vocational Education and Training (ECVET)

Investigate how transparency, comparability, transferability and recognition of competences and/or qualifications, between different countries and at different levels, could be promoted by

- developing reference levels,
- common principles for certification, and
- common measures, including a credit transfer system for vocational education and training

7 DECEMBER 2010

**The Bruges Communiqué on enhanced
European Cooperation in VET for the
period 2011-2020**

Key words

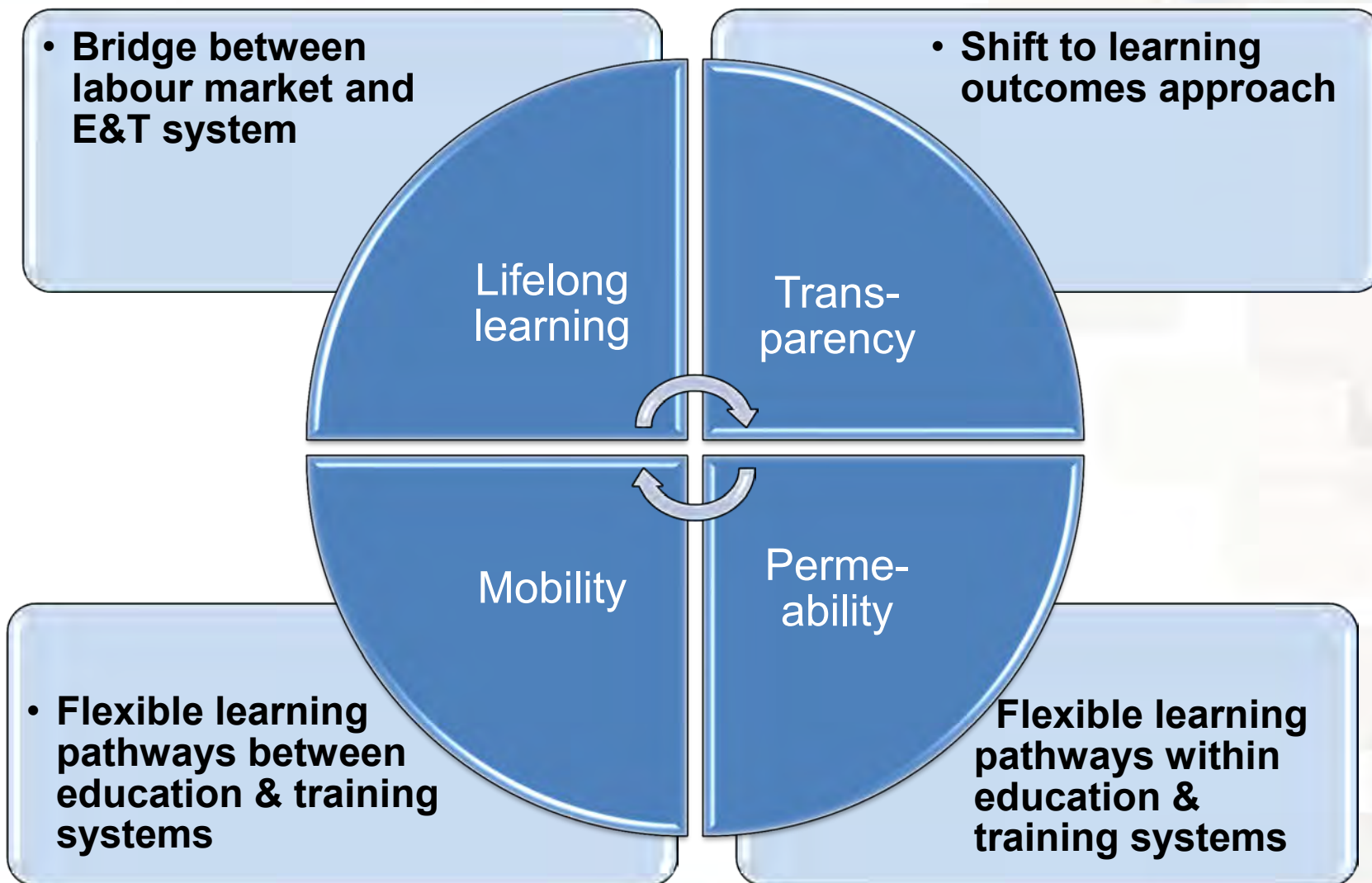

European Area of Skills and qualifications



Definition

ESCO

Common terminology to describe LO and professions

Level

EQF

Common understanding of the level of qualifications and LO

Learner's learning outcomes

Recognition

The principle of diversity of pathways & common processes of identification, assessment, validation and recognition of LO

To achieve formal qualifications

HE :
ECTS

VET:
ECVET

Non-formal/
informal learning

Validation

Documentation

Common formats for visibility of LO

EUROPASS

Quality of outcomes

Common processes to ensure quality of learning outcomes

HE
ESG

VET
EQAVET

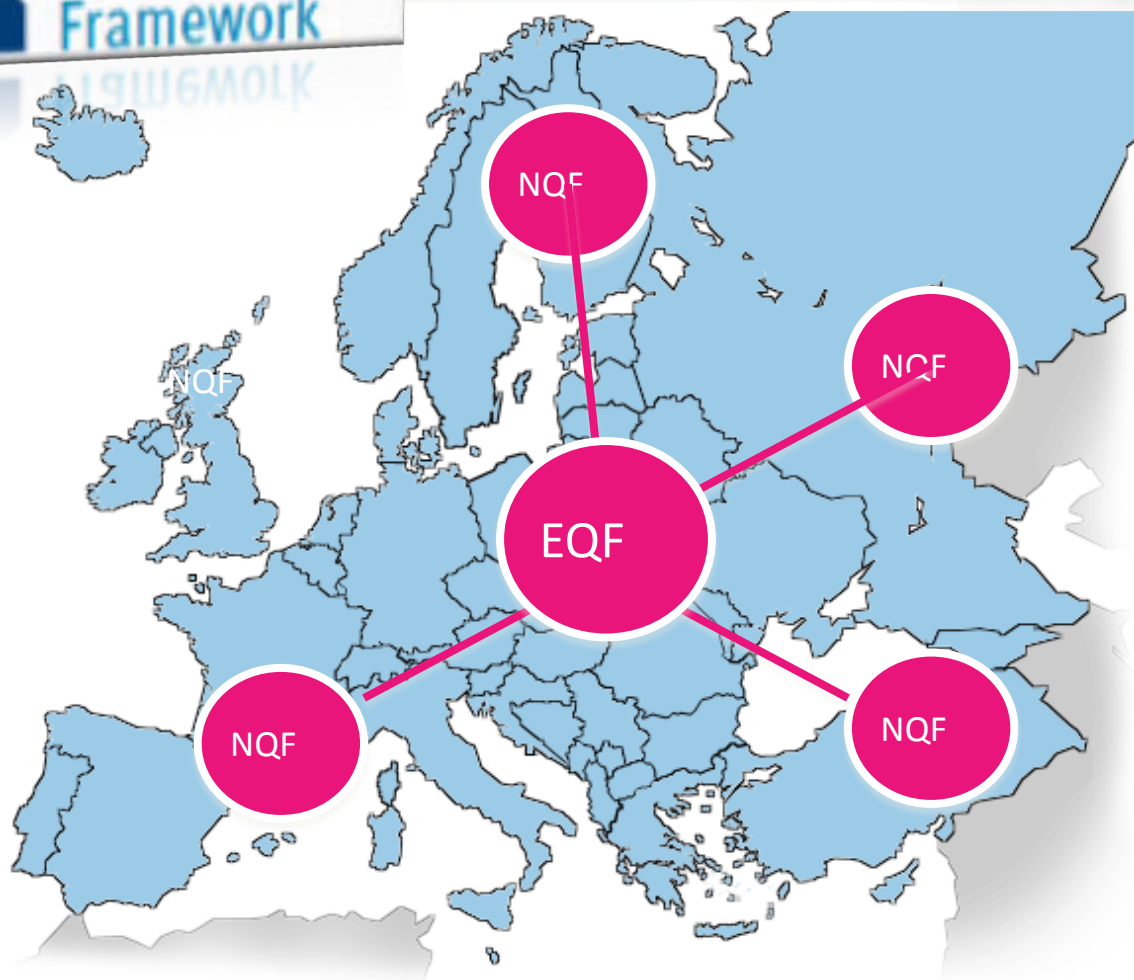

Learning outcomes in EQF



| Levels | Knowledge | Skills | Competence |
|--------|-----------|--------|------------|
| | | | |
| | | | |
| | | | |
| | | | |
| | | | |
| | | | |
| | | | |

Learning outcomes - what a learner knows, understands and is able to do on completion of a learning process

The 8 levels distinguished by:

- the complexity and depth of knowledge and understanding
- the degree of necessary support or instruction
- the degree of integration and independence required
- the range and complexity of practise/application
- the degree of transparency and dynamics of situations



EQAVET

European Quality Assurance
in Vocational Education and Training



Education and Culture DG



ecvet

European Credit system for
Vocational Education & Training

EU Quality Assurance

in Vocational Education & Training



Recommendation NFIL



- Validation means a process of confirmation by an authorised body that an individual has acquired learning outcomes measured against a relevant standard

- Identification (through dialogue)
- Documentation (visible experience)
- Assessment (of experiences)
- Certification (partial or full qualification)

(i) validation means a process of confirmation by an authorised body that an individual has acquired learning outcomes measured against a relevant standard and consists of the following four distinct phases:

- IDENTIFICATION through dialogue of particular experiences of an individual;
- DOCUMENTATION to make visible the individual's experiences;
- a formal ASSESSMENT of these experiences; and
- CERTIFICATION of the results of the assessment which may lead to a partial or full qualification;

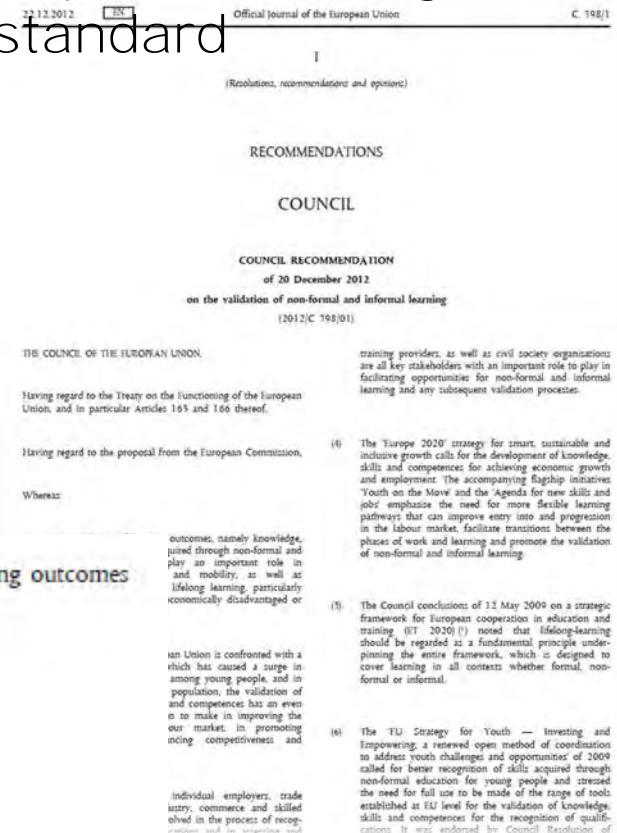

- Five documents to make your skills and qualifications clearly and easily understood in Europe

Curriculum Vitae



A document to present your skills and qualifications effectively and clearly

Create your CV online - Follow the instructions and save the completed document (download or e-mail).

Update your CV (PDF+XML) online

Download the CV template and instructions - You can then generate your CV on your computer.

Examples

[Learn more »](#)

Language Passport



A self-assessment tool for your language skills and qualifications

Create your Language Passport online - Follow the instructions and save the completed document (download or e-mail).

Update your Language Passport (PDF+XML) online

Download the Language Passport template and instructions - You can then generate your Language Passport on your computer.

Examples

[Learn more »](#)

The other Europass documents



Europass Mobility - A document to record knowledge and skills acquired in another European country

Certificate Supplement - A document describing the knowledge and skills acquired by holders of vocational training certificates.

Diploma Supplement - A document describing the knowledge and skills acquired by holders of higher education degrees.

National Europass Centres



In every country (European Union and European Economic Area), a National Europass Centre coordinates all activities related to the Europass documents. It is the first point of contact for any person or organisation interested in using or learning more about Europass.

[Learn more »](#)



ESCO - European Skills/Competences, qualifications and Occupations

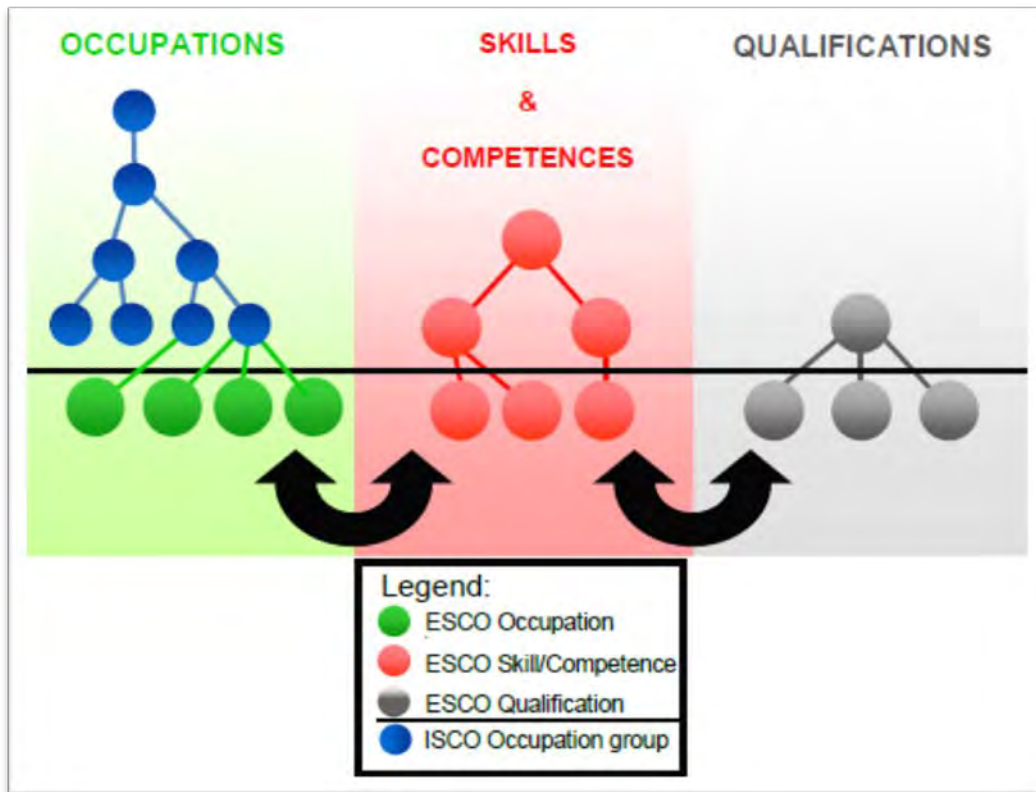

ESCO is the European multilingual classification linking skills and competences and qualifications to occupations and will be available to all labour market, education institutions and other stakeholders.



ECVET recommendation



Education and Culture DG



Official Journal of the European Union

C 155/11

RECOMMENDATION OF THE EUROPEAN PARLIAMENT AND OF THE COUNCIL
of 18 June 2009
on the establishment of a European Credit System for Vocational Education and Training (ECVET)
(Text with EEA relevance)
(2009/C 155/02)



ECVET: one of several EU tools



- The European credit system for vocational education and training (ECVET) is one of several European tools designed to make **qualifications systems more easily understood, transparent and flexible** throughout the European Union (EU) to **support more mobility for workers and learners**

How ECVET can help?



- **Qualifications** can be completed through different learning experiences – formal/non formal/informal
- ECVET can help in a number of learning experiences



8.7.2009

EN

Official Journal of the European Union

C 155/11

RECOMMENDATION OF THE EUROPEAN PARLIAMENT AND OF THE COUNCIL

of 18 June 2009

on the establishment of a European Credit System for Vocational Education and Training (ECVET)

(Text with EEA relevance)

(2009/C 155/02)

THE EUROPEAN PARLIAMENT AND THE COUNCIL OF THE EUROPEAN UNION,

Having regard to the Treaty establishing the European Community, and in particular Article 149(4) and Article 150(4) thereof,

- (3) VET schemes, one of the main areas of lifelong learning, are directly linked to general and higher education, and to the employment and social policies of each Member State. Through their cross-sectoral impact, they promote not only the competitiveness of the European economy and fulfilment of the needs of the labour market but also social cohesion, equality and the participation and involvement of citizens.

■ What is the objective?

■ Introduction

8.7.2009

EN

Official Journal of the European Union

C 155/11

RECOMMENDATION OF THE EUROPEAN PARLIAMENT AND OF THE COUNCIL

of 18 June 2009

on the establishment of a European Credit System for Vocational Education and Training (ECVET)

(Text with EEA relevance)

(2009/C 155/02)

- ✓ European Credit System for Vocational Education and Training (ECVET) is a **technical framework** for the **transfer, recognition** and, where appropriate, **accumulation** of individuals' **learning outcomes** with a view **to achieving a qualification**.

Recommendation



What has to be done?

HEREBY RECOMMEND THAT MEMBER STATES:

1. promote the European Credit system for Vocational Education and Training (ECVET) as set out in Annexes I and II at all levels of the EQF with reference to
2. create the necessary conditions and adopt measures, as appropriate, so that as from 2012 – in accordance with national legislation and practice, and on the basis of trials and testing – it is possible for ECVET to be gradually applied to VET qualifications at all levels of the EQF, and used for
3. support the development of national and European partnerships and networks involving institutions and authorities
4. ensure that stakeholders and individuals in the area of VET have access to information and guidance for using ECVET,
5. apply, in accordance with national legislation and practice, the common principles for quality assurance in VET set out in the
6. ensure that there are functioning coordination and monitoring mechanisms at the appropriate levels, in accordance with the legislation, structures and requirements of each Member State, in order to guarantee the quality, transparency and consistency of the initiatives taken to implement ECVET.

ENDORSE THE COMMISSION'S INTENTION TO:

1. support Member States in carrying out the tasks referred to in points 1 to 6 and in using the principles and technical specifications of ECVET as set out in Annex II, in particular by facilitating testing, cooperation, mutual learning,
2. develop users' guides and tools, and adapt relevant Europass documents, in collaboration with Member States, national and European experts and users; develop expertise for enhancing the compatibility and complementarity of ECVET and ECTS used in the higher education sector, in collaboration with VET and higher education experts and users at European and national levels; and provide regular information on the developments of ECVET:
3. promote, and participate together with the Member States in, a European ECVET network involving relevant VET stakeholders,
4. monitor and follow up the action taken, including the results of trials and testing, and, after the assessment and evaluation of this action carried out in cooperation with the Member States, report, by 18 June 2014, to the European Parliament and the Council on the experience gained and implications for the future, including, if necessary, a review and adaptation of this Recommendation, involving the updating of the Annexes and guidance material, in cooperation with the Member States.

Recommendation



- What has to be implemented?
 - ECVET — Principles and technical specifications

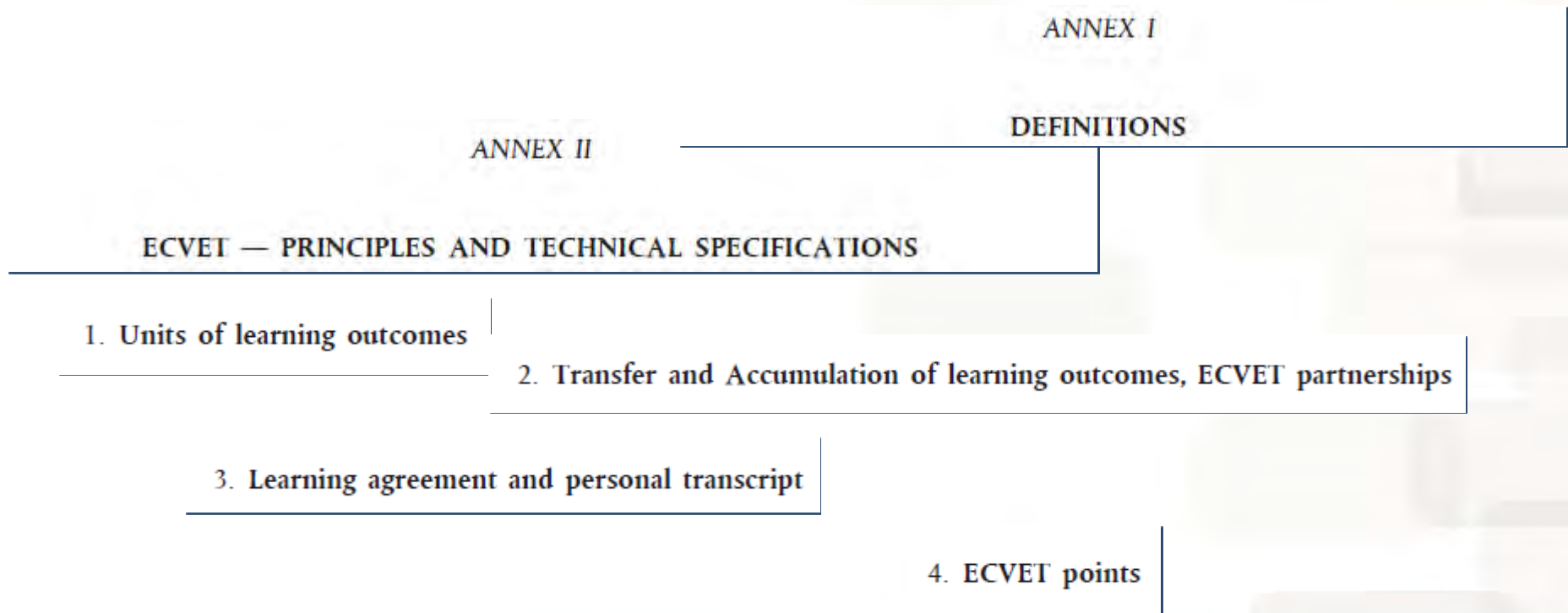

- ECVET tools and methodology comprise
 - the description of qualifications in terms of units of learning outcomes with associated points,
 - a transfer and accumulation process and
 - complementary documents such as learning agreements, transcripts of records and ECVET users' guides

ECVET principles



VET context Poland



Mr. X has an opportunity for a learning period

Learning experience UK



Mr X achieves learning outcomes

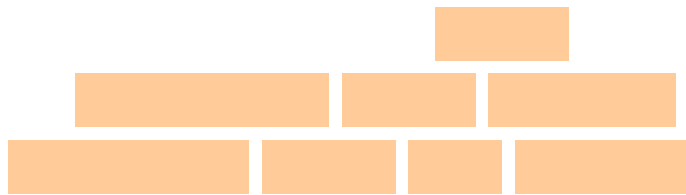

He wants to transfer "home" them in his qualification



- No accumulation
- No validation
- No transfer
- No common understanding

Transfer and accumulation of learning outcomes

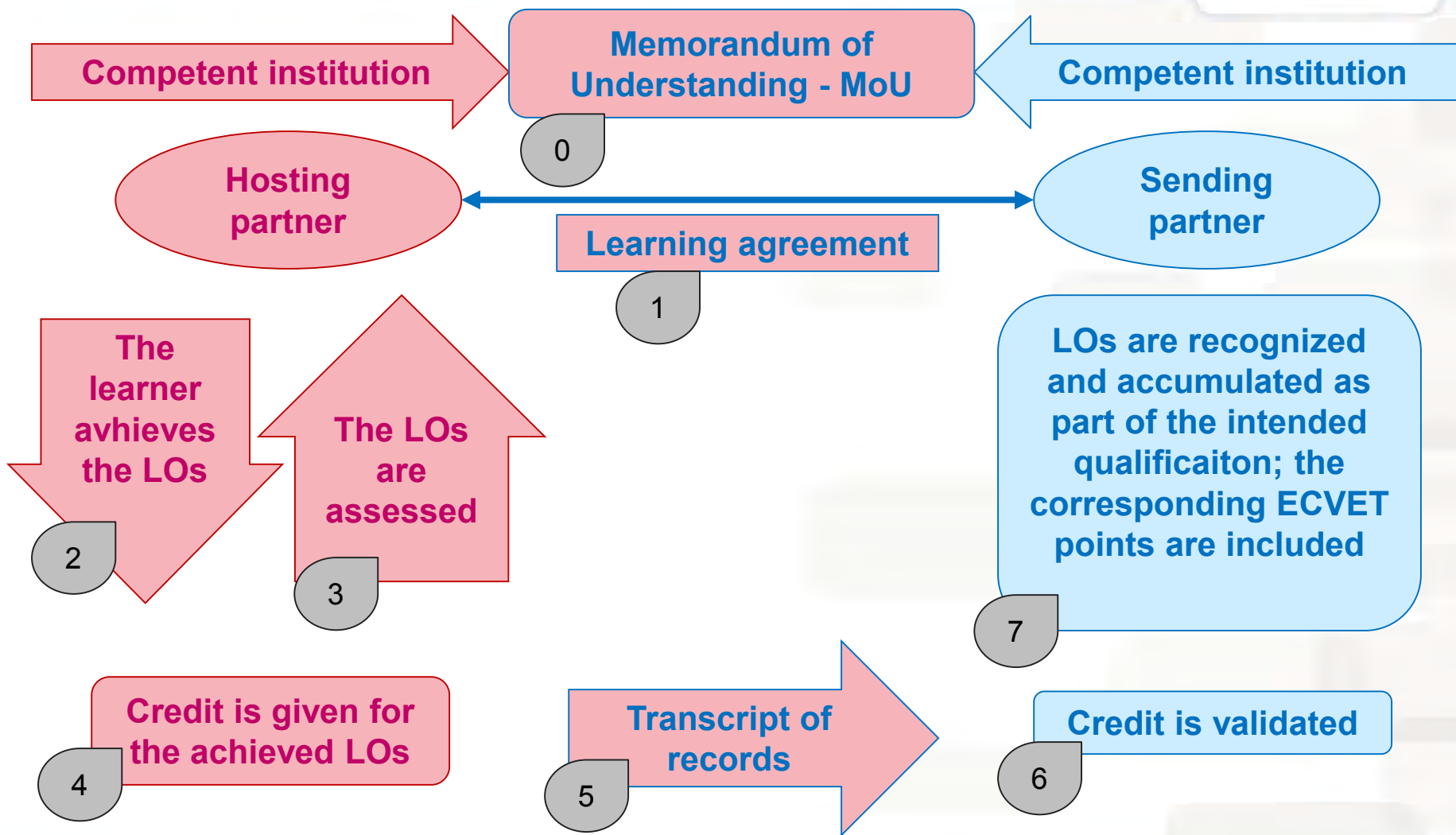

ECVET objectives and technical components



Transnational mobility

Lifelong learning

**R
e
c
o
g
n
i
t
i
o
n**

Learning outcomes

Transparency of qualifications

Accumulation process

Transfer process

Units of learning outcomes

ECVET points

Assessment of learning outcomes

Validation of learning outcomes

Recognition of learning outcomes

Memorandum of understanding (partnership)

Learning agreements

Transcript of record



LO & Units

European Credit System for Vocational Education and Training (ECVET) is a **technical framework** for the **transfer, recognition** and, where appropriate, **accumulation** of individuals' **learning outcomes** with a view **to achieving a qualification**.

Transnational mobility

Lifelong learning

R
e
c
o
g
n
i
t
i
o
n

Learning outcomes

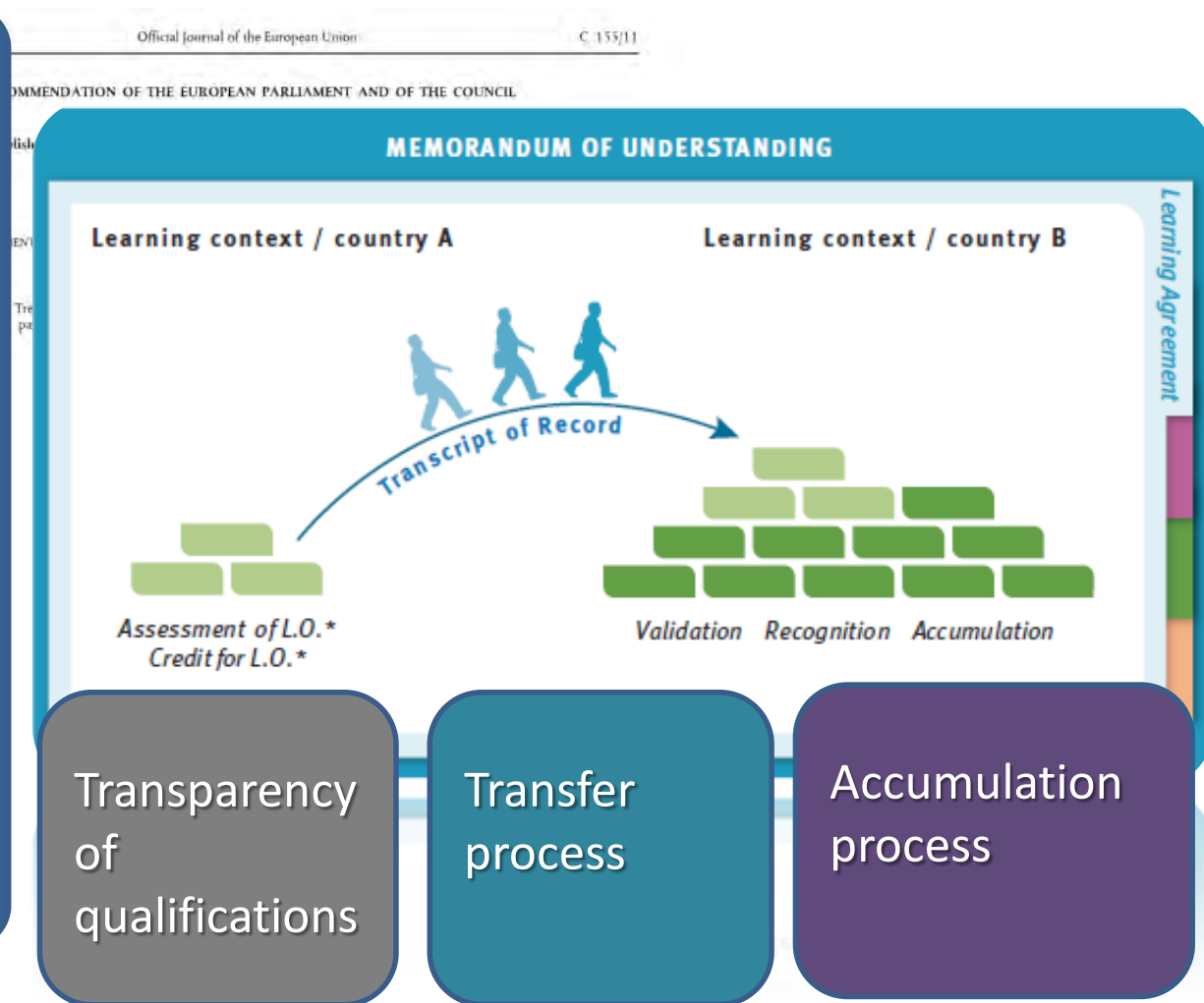

Transparency of qualifications

Transfer process

Accumulation process

Key pre-condition:
Learning outcomes approach to qualification

THE SHIFT TO LEARNING OUTCOMES

2.3. The challenge of describing learning outcomes

Conceptual, political
and practical developments in Europe

The shift to LO



- Increases **consistency** between the European tools (as they all follow this approach);
- **Linking** the occupational and the educational standards used for the definition of qualifications and VET learning processes, and, at a macro level, **education and the labour market**;
- Introducing a **common language**;
- **Clarifying** the relationships between different forms and contexts of learning;
- Raise discussion on the input-based perspective to education, training and qualifications purely based on location, duration and/or teaching methods and call for dialogue on the relevance and quality of qualifications. **Call for dialogue on the relevance and quality of qualifications**

Various purposes

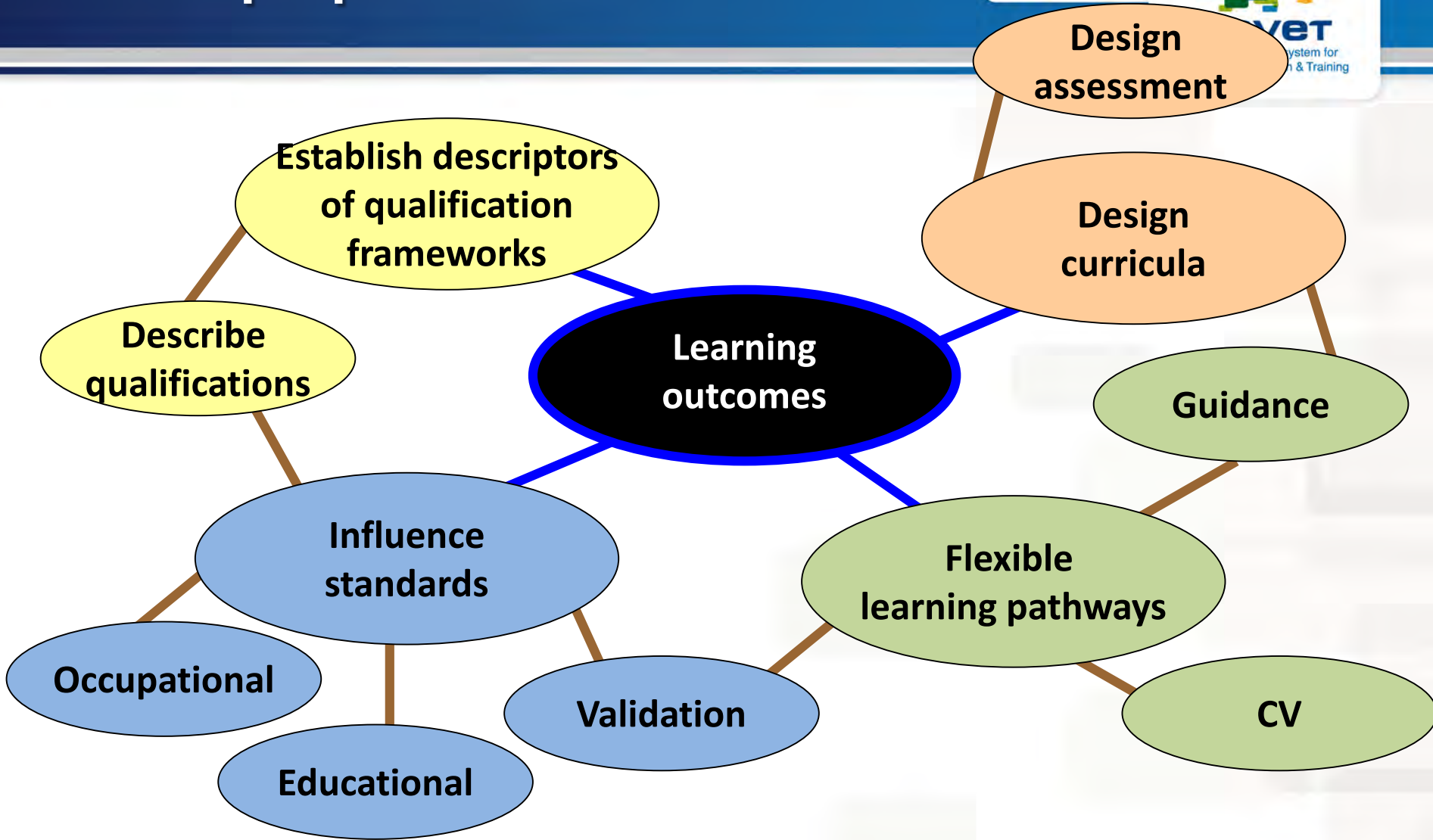

Learning outcomes in EQF



| Levels | Knowledge | Skills | Competence |
|--------|-----------|--------|------------|
| | | | |
| | | | |
| | | | |
| | | | |
| | | | |
| | | | |
| | | | |

Learning outcomes - what a learner knows, understands and is able to do on completion of a learning process

The 8 levels distinguished by:

- the complexity and depth of knowledge and understanding
- the degree of necessary support or instruction
- the degree of integration and independence required
- the range and complexity of practise/application
- the degree of transparency and dynamics of situations

- **'Knowledge'** means the outcome of the assimilation of information through learning. Knowledge is the body of facts, principles, theories and practices that is related to a field of work or study.
- **'Skills'** means the ability **to apply knowledge and know-how** to complete tasks and solve problems.
- **'Competence'** means the proven ability to use knowledge, skills and personal, social and/or methodological abilities, in work or study situations and in professional and personal development. **In the context of the EQF competence is described in terms of responsibility and autonomy.**

Knowledge

The professional driver knows legal regulations For driving times and rest periods

Skills

The professional driver can practically apply legal regulations for driving times and rest periods manage time

Competence

He/She considers the legal requirements on driving times and rest periods.
He/She applies the relevant legal regulations during the tour consequently.
He/She decides under special consideration of her/his responsibility within road traffic and shows a professional behaviour as well as integrity



REPUBLIKA SLOVENIJA
MINISTRSTVO ZA DELO,
DRUŽINO IN SOCIALNE ZADEVE

Competences relate to the ability to use and integrate knowledge and skills in educational, work and personal situations. We distinguish between generic and vocationally specific competences. Competences are classified in the SQF in terms of complexity, autonomy and responsibility.

NLQF descriptors

Context

The context descriptions of the levels are used along with the described knowledge to determine the grade of difficulty of the skills

- **Applying knowledge**
- **Problem solving skills**
- **Learning and development skills**
- **Information skills**
- **Communication skills**

- Communication skills
- Information skills
- Learning and development skills
- Problem solving skills
- Applying knowledge

| Level 1 | | | |
|---------------------------------|--|--|------------|
| NLQF | | EQF | |
| Context | A familiar daily living or working environment | | |
| Knowledge | Possess basic knowledge of simple facts and ideas related to an occupation or a knowledge domain | Basic general knowledge | Knowledge |
| Applying knowledge | Reproduce and apply this knowledge Carry out simple and familiar (professional) tasks automatically | | |
| Problem-solving skills | Recognise and solve simple problems in professional practice or in the knowledge domain | | |
| Learning and development skills | Work under supervision on personal development | Basic skills required to carry out simple tasks | Skills |
| Information skills | Obtain and process information, simple facts and ideas related to the occupation or knowledge domain | | |
| Communication skills | Communicate with peers, supervisors and clients, appropriately to the context, using conventions which are relevant to professional practice | | |
| Responsibility and independence | Work with peers, supervisors and clients Under supervision, take responsibility for the results of simple tasks or study | Work or study under direct supervision in a structured context | Competence |

EQUFAS framework



ecvet
European Credit system for
Vocational Education & Training

| | | 1 | 2 | 3 | 4 | 5 | 6 | 7 | 8 |
|----------------|-----------------------|---|---|---|---|---|---|--|---|
| responsibility | Responsibility | carries out tasks under supervision | responsible for the tasks | responsible for its own actions + preparing, carrying out and closing | responsible for the full cycle of doing tasks, including reflection | responsible for the full cycle of doing tasks, including reflection on the tasks done by others | responsible for a team or a project | responsible for one or more teams, projects or a company | responsible for the strategy, vision and coordination of programmes |
| | Autonomy | carries out tasks under supervision after clear explanation | carries out tasks under supervision after clear explanation | carries out tasks autonomously after directed explanation * fully responsible for carrying tasks and shows initiative | carries out tasks autonomously in deliberation | has a mandate to carry out tasks autonomously and shows initiative | independent in the way they think and act * carries out tasks autonomously, entrepreneurial | independent in the way they think and act | fully responsible for carrying tasks and shows initiative |
| range | Public | I, you and he | students in classroom | colleagues and customers | contacts in the working environment | colleagues and customers | divers people from layman to specialists | all employees and regional contacts of the company | employees, national contacts of the company, critical customers, government and NGO's |
| | Timeline | Hours | Days | Weeks | Months | Months | 1 to 5 years | 5 to 10 years | next generation, 10 to 30 years, historical awareness and being able to deal with the short term and longer term constraint |

| | | | | | | | | | |
|------------|------------------------------------|--------------------------------------|---|--|---|--|---|---|--|
| complexity | Tasks | simple sub tasks | simple tasks | several tasks in the same time | schedules - combination of tasks | combines and coordinates tasks | is able to analyze the work that has to be done in several tasks | has an overview of the consequences of his own work and the work of others | has an overview and understands the complexity and diversity of tasks |
| | Procedures | routine production | basic, explorative, productive | is able to adjust standard procedures | orientation, exploring, productive | to able to adjust standard procedures | develop new procedures | methodically and systematic analyzing | To innovate is a basic strategy |
| | Knowledge and understanding | knows functional facts | knows facts and is able to understand simple explanations | knows facts and methods and is able to explain | knowledge of facts and methods; applying knowledge in concrete situations | knows facts and methods and is able to explain Knows facts and methods and is able to apply knowledge in practical situations | knows facts, methods and principles, is able to form arguments to analyze and to deliberate and is able to transfer special knowledge | combine facts, methods and principles and is able to integrate different disciplines to formulate arguments, to analyze and to deliberate,... | develops new theories, concepts and models |
| transfer | Ambiguity | transfer in steady context | transfer in situations with limited changing factors | transfer in situations with several changing factors | transfer related context | transfer in continuously changing context | transfer in a dynamic context | transfer in complex and hard to predict factors | integrates different contexts, making use of temporary,... and social-cultural aspects |
| | Change | changes under supervision | changes after instruction | is able to adjust oneself | is able to adjust the task in changing situations | is able to manage changes and to complete changes | is able to direct changes, to initiate changes, to come with new ideas for changes from practice | is proactive, comes first with new ideas, is able to design changes | is able to develop new concepts and takes the lead in realising changes |
| | Range | is able to transfer within the tasks | is able to transfer within the area of tasks | is able to transfer within the profession | is able to transfer within the sector | is able to transfer in related sectors | is able to transfer between the sector | able to integrate different disciplines | develops from another discipline |

What's the definition of C for the Nuclear sector?



- **'Competence'** means the proven ability to use knowledge, skills and personal, social and/or methodological abilities, in work or study situations and in professional and personal development.
 - **Autonomy**
 - **Responsibility (Independence)**
 - **Public** National contacts, Government
 - **Timeline** Next generation 10 – 30 years
 - **Tasks** Overview and understands complexity and diversity
 - **Ambiguity** Integrates different contexts
 - **Range** Able to integrate different disciplines
 - **Change** Able to develop new concepts

LO Exercise K,S,C



- He/she is able to
 - ... receive orders and plan own procedural steps
 - ... explain regulations concerning the handling of hazardous substances
 - ... delegate the service and maintenance tasks taking into account specifications
 - ... communicate sincerely with clients
 - ... analyse data and present it as a basis for decisions
 - ... differentiate between separation and mix principles and corresponding procedures
 - ... develop a marketing plan and use marketing and PR instruments
 - ... reflect upon his/her own action
 - ... assign the necessary documents for service and maintenance

How are learning outcomes formulated? – Exercise K,S,C



- Competence - He/she is able to
 - ... delegate the service and maintenance tasks taking into account specifications
 - ... reflect upon his/her own action
 - ... communicate sincerely with clients
- Skills - He/she is able to
 - ... receive orders and plan own procedural steps
 - ... analyse data and present it as a basis for decisions
 - ... develop a marketing plan and use marketing and PR instruments
- Knowledge - He/she is able to
 - ... explain regulations concerning the handling of hazardous substances
 - ... assign the necessary documents for service and maintenance
 - ... differentiate between separation and mix principles and corresponding procedures

Descriptors defining level



Each of the 8 levels is defined by a set of descriptors indicating the L.O. relevant to qualifications at that level in any system of qualifications

| Knowledge | Skills | Competence |
|---|---|--|
| Is described as theoretical and/or factual | Are described as cognitive and practical | Is described in terms of responsibility and autonomy |
| <p>Level 1: Basic general knowledge <i>Level 2-7 hierarchy of 'knowledge':</i> <i>Factual</i> <i>Facts, principles, processes and general concepts</i> <i>Comprehensive, specialised</i> <i>Awareness of boundaries</i> <i>Advanced</i> <i>Highly specialised</i></p> <p>Level 8: Knowledge at the most advanced frontier of a field of work or study and at the interface between fields</p> | <p>Level 1: Basic skills required to carry out simple tasks <i>Level 2-7 hierarchy of 'solve problems':</i> <i>routine – specific– abstract– complex and unpredictable – critical</i></p> <p>Level 8: The most advanced and specialised skills and techniques, including synthesis and evaluation, required to solve critical problems in research and/or innovation and to extend and redefine existing knowledge or professional practice</p> | <p>Level 1: Work or study under direct supervision in a structured context <i>Level 2-7 hierarchy of 'contexts':</i> <i>usually predictable – unpredictable change – unpredictable – complex, unpredictable and require new strategic approaches</i></p> <p>Level 8: Demonstrate substantial authority, innovation, autonomy, scholarly and professional integrity and sustained commitment to the development of new ideas or processes in the forefront of work or study contexts including research</p> |

LO exercise EQF level



- take responsibility of planning their own work
- make creative solutions to abstract problems of the marketing concept after possible consultation with the marketing department and to filter important information for them
- follow concrete instructions of the team manager on tasks to be performed
- carry out simple tasks on planning the design process (textile)
- differentiate processing methods, production possibilities, quality standards and production means

LO exercise EQF level



- take responsibility of planning their own work (3)
- make creative solutions to abstract problems of the marketing concept after possible consultation with the marketing department and to filter important information for them (5)
- follow concrete instructions of the team manager on tasks to be performed (1)
- carry out simple tasks on planning the design process (textile) (2)
- differentiate processing methods, production possibilities, quality standards and production means (4)

Exercise (the best and worst)



- Knows the regional products and is able to prepare simple meals
- Know and understand about the production of agricultural products which adhere to organic farming principles and regulatory and advisory frameworks
- Produce organic livestock according to a quality controlled and productive mechanism
- A variety of cells is described correctly in relation to their structure and functions
- Is able to manage export logistics
- The skills and knowledge required to manage export logistics in accordance with relevant regulatory requirements and workplace procedure, including planning efficient export logistics operations, developing appropriate contingency management strategies for export logistics and monitoring and coordinating the required systems for export logistics
- Is able to coordinate internal and cross-plant supply and logistics chains
- Carry out international business location or regional planning projects

Basic knowledge about the different systems of NPP



- compile
- identify
- create
- plan
- revise
- analyse
- design
- select
- utilize
- apply
- demonstrate
- prepare
- use
- compute
- discuss
- explain
- predict
- assess
- compare
- rate
- critique
- outline
- evaluate

LO recommendations



- Learning outcomes are statements of what a learner **knows, understands and is able to do** on completion of a learning process
- Definitions K,S,C
- Design C or K,S,C
- EQF descriptors / levels
- Use **clear statements** and appropriate articulation: **Using verbs** (instead of listing content-related nouns) allows for describing activities rather than describing lists of content-related items that have to be learnt
- The description of activities (verbs) should be **linked with a reference point** i.e., with the type of activity that is involved and/or what the knowledge, skills and competences aim at.

- A unit is a component of a qualification, consisting of a **coherent set of knowledge, skills and competence** that can be assessed and validated
 - Identify what learners can learn
 - Describe the learning outcomes that the learner is expected to achieve
 - It's feasible what is to achieve
 - The credit to this unit can be recognised

Units

The image features a decorative background with a white base and a dark blue horizontal band across the middle. The word "Units" is written in white on the left side of the band. The background is adorned with numerous overlapping rounded rectangles in various colors: blue, orange, green, and red. Some rectangles are solid, while others are outlined in a light blue color. The rectangles are scattered across the page, with a higher concentration on the right side.

Units in relation to qualifications



- Depending on the existing regulations, units may be common to several qualifications
- or specific to one particular qualification

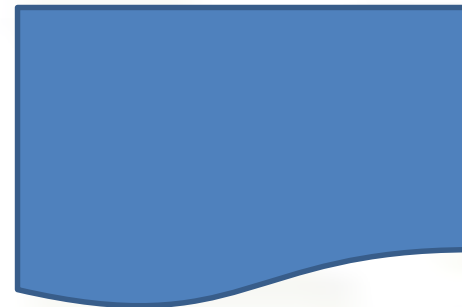
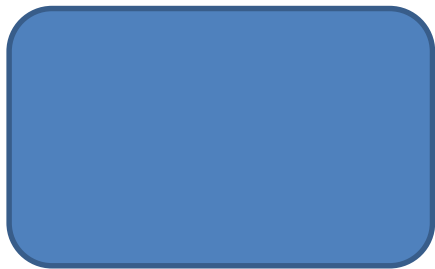

How can learning outcomes be grouped to create units?



- Units should be constructed and organised in a coherent way with regard to the overall qualification,
- criteria according to which learning outcomes can be grouped:
 - related to the same set of occupational activities/tasks
 - related to the same product or production technique
 - related to the stages in the production process or process of performing a service
 - related to the same field of knowledge, skills or competence

How can learning outcomes be grouped to create units?



- The fact that they are related to the same product or production technique



How can learning outcomes be grouped to create units?



- They can also be grouped according to the stages in the production process or process of performing a service
 - (Baltic education)

| | |
|---------|---|
| Unit 0: | Education (common studies and general capabilities) |
| Unit 1: | Paintwork |
| | <i>Unit 1.1: Indoor</i> |
| | <i>Unit 1.2: Outdoor (Facade)</i> |
| Unit 2: | Glue and Wallpaper work |
| Unit 3: | Object lacquering (and metal painting) |
| Unit 4: | Dam work |
| Unit 5: | Floor covering work |
| Unit 6: | Plasterwork (no preparation work) |
| Unit 7: | Dry mortarless construction work |
| Unit 8: | Designing and renovation work (specialisation) |

How can learning outcomes be grouped to create units?



- They can be grouped in a unit because they relate to the same field of knowledge, skills or competence



How can learning outcomes be grouped to create units?



- The learning outcomes relate to the same set of occupational activities/tasks

| Units | Sub-Units |
|---|--|
| International Marketing | Market research and market planning on foreign markets |
| | Business information system |
| Export Selling | Prospecting and customer/partner follow up |
| | Negotiating |
| Import Buying | Identifying potential suppliers and sourcing |
| | Organising the negotiation |
| Managing International Trade Operations | Choosing and working with service providers |
| | Managing the international business administration |
| Working in a Multicultural Context | Business English language A |
| | Business foreign language B |
| | Intercultural management and communication |

Advantages

- Units can be obtained in a rather short period of learning and therefore are particularly **suitable for geographical mobility**
- They can also be suitable for adult learners who combine learning and employment or learners who are at risk of dropping out from longer programmes

Disadvantages

- Because of the greater number of units in a qualification, this approach implies putting in place **a large number of assessments**
- Fragmentation of qualifications and of assessments may **make it more difficult to identify whether the learner can combine all the knowledge, skills and competence in a more complex manner**

Advantages

- Assessment of a larger unit enables learners to demonstrate their capacity to **combine knowledge, skills and competence in view of delivering a more complex service or a product**
- The **number of summative assessments is small**

Disadvantages

- **More substantial amount of learning activities is required to prepare for a unit.** Hence it may be **difficult** to achieve a full unit in the context of a **short transnational mobility period**
- The duration of learning activities preparing for the unit may be **too substantial for learners outside initial VET** to be able to benefit from accumulation

Criteria for developing units



There are several criteria that should be considered for developing units of learning outcomes::

- Units of learning outcomes should be designed in a way that they can be completed as independently as possible of each other.
- Units of learning outcomes should include all necessary learning outcomes, i.e. they should describe all intended shades of knowledge, skills, and competences.
- The scope, volume, complexity and level of difficulty of units of learning outcomes should be described realistically.
- Units of learning outcomes should be assessable.
- If the overall qualification is not (yet) linked with a particular EQF/NQF level, then the units of learning outcomes should be linked with the appropriate level in the EQF/NQF.

ECVET points



■ What is the difference between ECVET points and credit?

- ECVET points are **not** to be confused with credit.
- **Credit** designates *the learning outcomes the learner has achieved*.
- **Credit** is transferred and accumulated.
- **ECVET points** provide information about the qualification and the units.
- **ECVET points** provide information about the credit the learner has transferred and accumulated.

- Allocation of ECVET points to a **QUALIFICATION** is based on a convention according to which 60 points are allocated to the learning outcomes expected to be achieved in a year of formal full time VET
- Allocation of ECVET points to a **UNIT** is based on its relative weight within the qualification
 - The **relative importance of the unit LOs for labour market**, for progressions to other qualification levels or for social integration
 - The **complexity**, scope and **volume** of the unit LOs
 - The **effort necessary for a learner** to acquire the knowledge, skills and competence required for the unit

Example ECVET points



| SALES ASSISTANT | Labour Market | Complexity | Workload | and finally... |
|----------------------|-----------------|-----------------|-----------------|----------------|
| Ordering Process | 20% (12) | 25% (15) | 15% (9) | ? |
| Selling Process | 30% (18) | 20% (12) | 40% (24) | ? |
| Presentation Process | 20% (12) | 20% (12) | 15% (9) | ? |
| Financial Process | 25% (15) | 30% (18) | 15% (9) | ? |
| Maintenance Process | 5% (3) | 5% (3) | 15% (9) | ? |



Key aspect Qualification design (assessment)

FLOW: Assessment



■ 4 groups – circulate document 2 questions
– summary a final statement

- Intro Ass 15 min Rob
- Exc intrio 5 min Thierry
- Work on Q1 – Q2 20 min
- Work on Q2 – Q1 20 min
- Summ up 10 min
- Feedback 20 min

Moving between general and vocational education ('permeability')

In qualification systems, qualifications at EQF level 4 are frequently used to test ECVET. Level 4 is a 'traditional' vocational qualification level, even though ECVET is expected to cover all levels of EQF.

In higher education, ECTS is another credit transfer system established to ease credit transfers between higher education institutions and developed in the Bologna process framework. It is primarily and to a large extent based on inputs such as course length and number of hours.

While for the moment ECTS and ECVET are developed separately, bridges between the two systems would also ease permeability between vocational and other qualifications. Current attempts to define ECTS in terms of learning outcomes may be a step in supporting their convergence.

ECVET and ECTS

- A systematic dialogue between VET and higher education is needed and this is where the relationship ECVET-ECTS has to be addressed
- This dialogue should address how the two credit transfer systems can interact to facilitate transfer and recognition
- This dialogue must address the political as well as technical conditions for transfer and recognition
- Need a focus on the learner (moving upwards, downwards and sideways) - the credit systems are instruments, not aims in themselves

The development of ECVET in Europe



 **CEDEFOP** | European Centre for the Development
of Vocational Training

WORKING PAPER

No 22

Monitoring ECVET
implementation
strategies in Europe
in 2013

CEDEFOP

- Survey of 38 countries/regions
- National VET contexts: presence of units/modules, transfer and accumulation possibilities
- Perceived added-value
- Status of policy making – is there a policy decision to use ECVET in reforming VET systems

■ Challenges – what works, what doesn't

- More time to understand whether and/or how ECVET may be implemented in the national VET systems
- More clarity of purposes, and streamlining on the basis of what works or does not work in practice
- Acknowledgement that ECVET is a toolbox or concept, rather than a system containing technical specifications

The country clusters

Cluster I: countries with units/modules and credit systems

ES, FI, IE (all CAS, excluding apprenticeship), IS, LU, RO, SE, SI, UK.

Cluster II: countries with units/modules and no credit systems

BE-DE, EE, FR (all qualifications of the Ministry of Education), HR, HU, NL, PL, PT, RS, TR.

Cluster III: countries without units/modules and predominantly apprenticeship-based IVET

AT, CH, DE, DK, LI, NO.

Cluster IV: countries without units/modules and predominantly school-based IVET

BE-FL, BE-FR, BG, CY, CZ, EL, IT, LT, LV, ME, MK, MT, SK.

ECVET added value (geographical mobility)

Could ECVET bring added value in improving transfer in the home country of learning acquired abroad? (number of opinions)

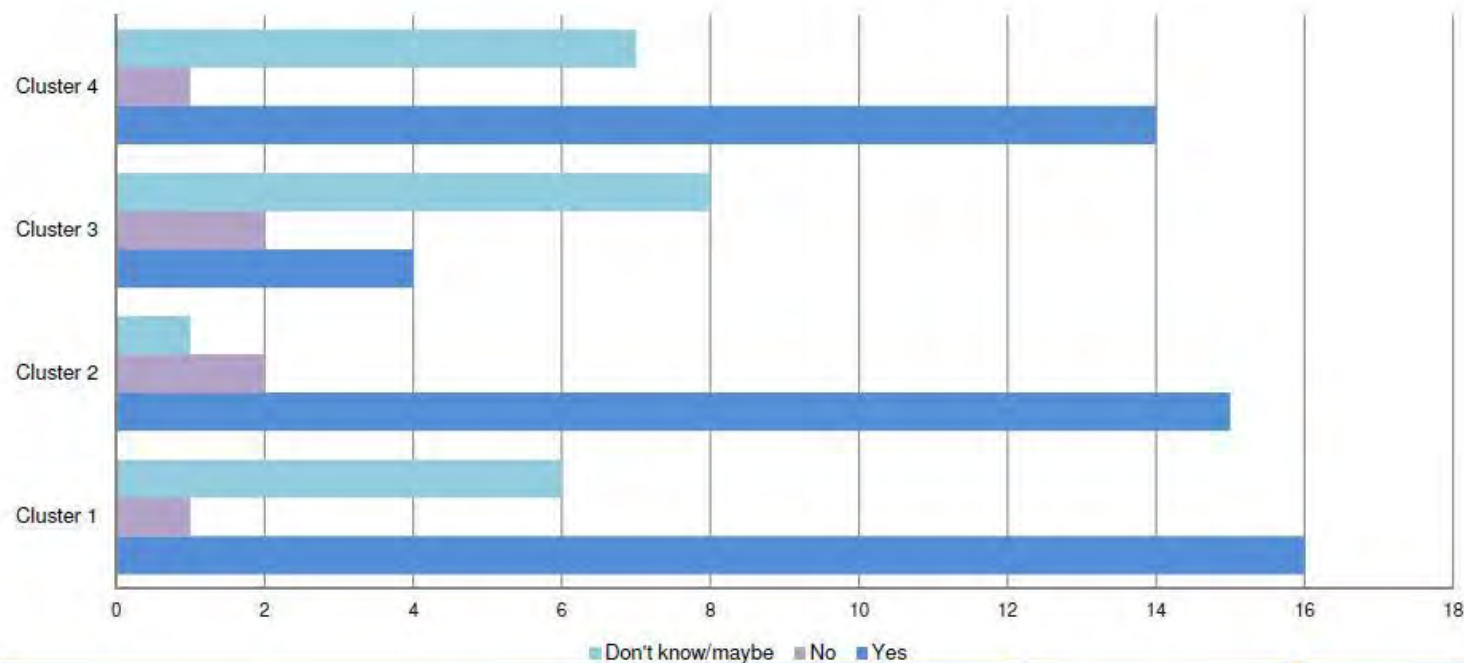

European Credit System for Vocational Education and Training (ECVET) is a **technical framework** for the **transfer, recognition** and, where appropriate, **accumulation** of individuals' **learning outcomes** with a view **to achieving a qualification**.

Transnational mobility

Lifelong learning

R
e
c
o
g
n
i
t
i
o
n

Learning outcomes

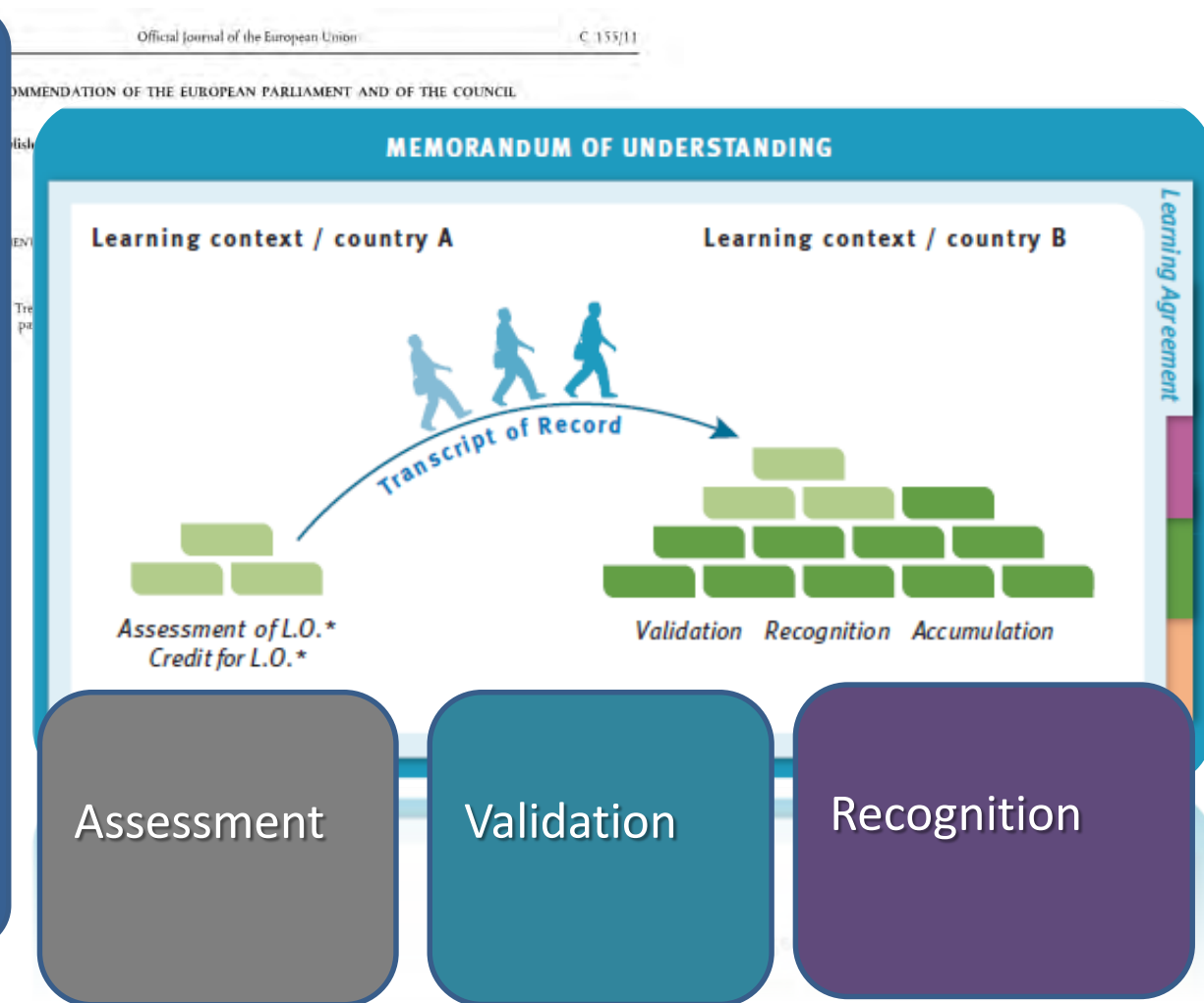

Assessment

Validation

Recognition

Assessment

Validation

Recognition



■ **Assessment** of learning outcomes

- establish the extent to which a learner has in fact attained particular knowledge, skills and competence

■ **Validation** of learning outcomes

- confirming that assessed learning outcomes achieved by a learner correspond to specific outcomes which may be required for a unit or a qualification

■ **Recognition** of learning outcomes

- means attesting officially achieved learning outcomes through the awarding of units or qualifications

Establish the extent to which a learner has in fact attained particular knowledge, skills and competence

- Making the decision (performance measurement)
 - what evidence, comparison gap between performance and standards, assessors
- Checking the decision
 - Quality Assurance, Validation
- Using the decision
 - In the ECVET perspective in a context of mutual trust, Transfer & Recognition

Performance measurement (in a context)

ECVET = Design of Units of L.O. & Trust & Transfer

- *Design (units)*

L.O. ↔ Assessment (in context)

consistency

- *Trust*

- Consistency and the quality of the Assessors

- *Transfer*

- In the ECVET context the result of the performance measurement but also Transfer

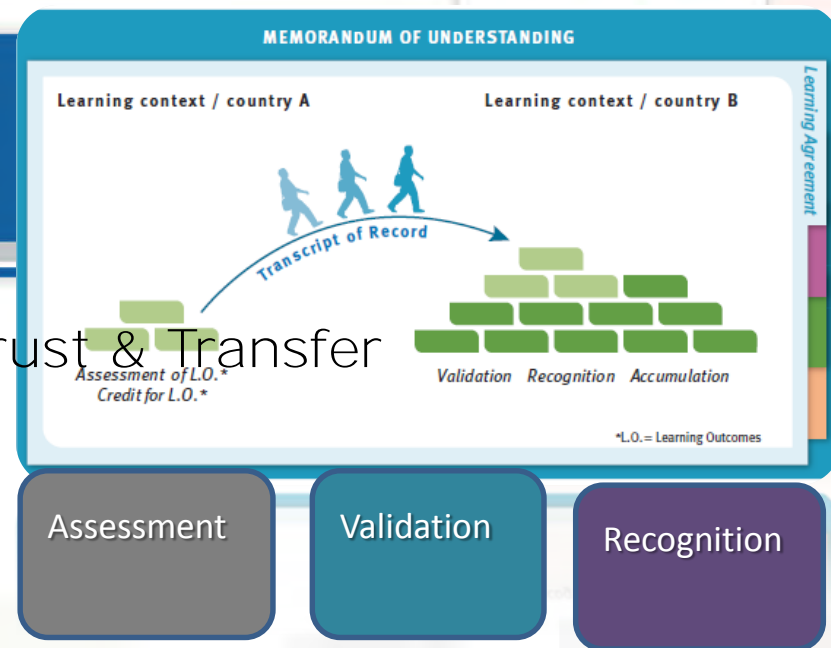

The key conditions for assessment in the perspective of T&R



- Quality of the LO / units
- Agreement partners
- Quality of the assessors
- Consistency of the assessment tools in relation with LO and context
- Transparency of assessment protocols

Q1: The key conditions



- The key conditions for assessment in the perspective of T&R in the NUCLEAR SECTOR
 - Quality of the LO / units
 - Agreement partners
 - Quality of the assessors
 - Consistency of the assessment tools in relation with LO and context
 - Transparency of assessment protocols
 -

Q2: The documentation



- How to document the achieved L.O. in the perspective of T&R in the nuclear sector

The image features a white background with a dark blue horizontal band across the middle. On the right side, there is a cluster of overlapping, semi-transparent rounded rectangles in various colors: blue, orange, green, red, and dark green. The text 'Recognised mobility' is written in white on the dark blue band.

Recognised mobility

Different types of mobility



| Level | Objectives | Content | Partners | Partnership agreement | Pre-requisites |
|---|--|---|--|---|---|
| Level 1 Study visit/ Preparatory visit | EXPLORING Set up dynamics Explore conditions for possible mobility actions | Few days mobility No reciprocity in case of group mobility Professional visits/meetings Exploring-focus program | No still settled | No partnership agreement | Will to discover if pre-conditions for more sustainable mobility may exist |
| Level 2 First run of mobility | TESTING Pedagogical project, based on a job-approach Test of the partnership and of the logistic framework | Short length (at least 2 weeks) Reciprocity (or not) in case of group mobility Placement in companies (length can vary) "Classical" (soft) pedagogical program | ▶ VET centres, companies ▶ optional: institutional bodies, professional organisations | Basic partnership agreement <u>Necessary elements:</u> Group of learners or individual learners involved Mobility calendar Financial resources Logistic agreement | Capability to implement a mobility action (from the logistic point of view) Capability to suggest a relevant content Capacity to finance the action |

Different types of mobility



| Level | Objectives | Content | Partners | Partnership agreement | Pre-requisites |
|--|---|--|---|---|---|
| Level 3 Structured mobility | <p>STRUCTURING</p> <p>Strengthening linguistic skills</p> <p>In-depth pedagogical work</p> <p>Agreement between VET centres aiming at perpetuate the action</p> | <p>In-depth mobility project</p> <p>Average length (or combined short actions)</p> <p>Reciprocity (highly recommended) in case of group mobility</p> <p>Placement in companies</p> <p>In-depth pedagogical program</p> | <ul style="list-style-type: none"> ▶ VET centres, companies ▶ optional: institutional bodies, professional organisation | <p>Detailed partnership agreement</p> <p><u>Necessary elements:</u></p> <p>Group of learners or individual learners involved</p> <p>Mobility calendar</p> <p>Financial resources</p> <p>Logistic agreement</p> <p>In-depth pedagogical program</p> <p>Middle/long term agreement</p> | <p>Fulfil the level 2 pre-requisite (having experience on level 1) and:</p> <p>Capability to develop (design, and implementation) an in-depth pedagogical program</p> <p>Capability to be committed for a middle/long term</p> |

Different types of mobility



| Level | Objectives | Content | Partners | Partnership agreement | Pre-requisites |
|---|--|---|---|--|---|
| Level 4 Recognised mobility “ECVET Mobility” | <p>RECOGNITION</p> <p>Validation of unit(s) of learning outcomes acquired abroad</p> | <p>In-depth mobility project Minimum average length (or combined short actions) according to the trade concerned Reciprocity (or not) in case of group mobility In-depth pedagogical program Learning outcomes clearly defined</p> <p>Assessment and transfer defined</p> | <ul style="list-style-type: none"> ▶ VET centres, companies ▶ professional organisations, institutional bodies <p>(including competent institutions)</p> | <p>Very detailed partnership agreement</p> <p><u>Necessary elements:</u> Group of learners involved Financial resources In-depth pedagogical program including: units of LO, assessment process and transfer.</p> <p>MOU and LA</p> | <p>Fulfil the level 3 pre-requisites (having experience on level 1 and 2) and:</p> <p>Partners are all committed and legitimated to develop (design, implementation and assessment) a deep pedagogical content</p> <p>Legitimacy to assure transfer procedure</p> |

Tools for ECVET mobility

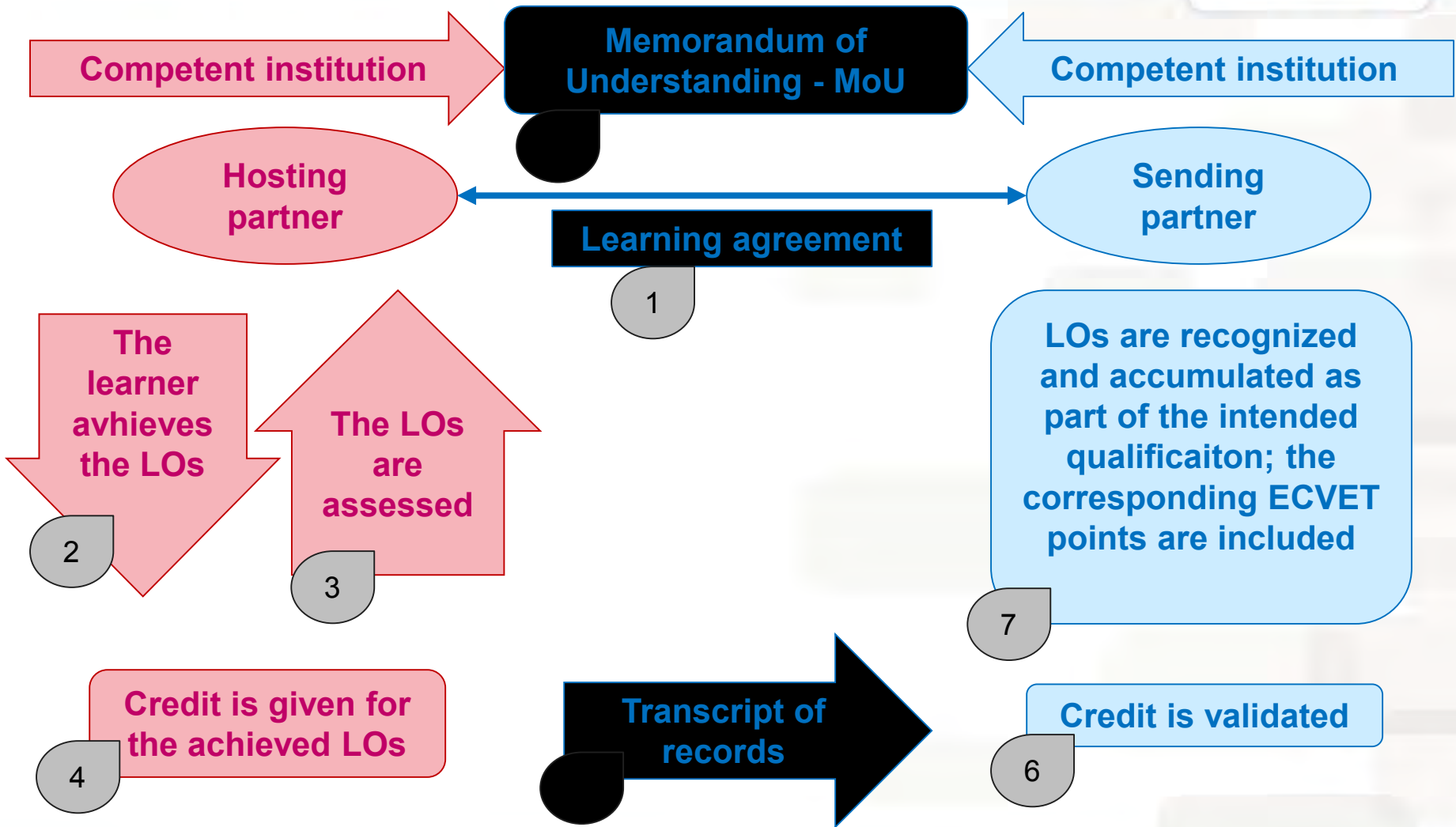

FLOW Q3: Mobility



- What's your position in mobility?
- Ideas for improvement?

- Discussion on their position in mobility
 - 15 min
- Individual feedback – 5 min
- Ideas for improvement

Q3: Mobility



- What's your position in mobility?
- Ideas for improvement?



Day 2 Involving stakeholders

Tools for ECVET mobility

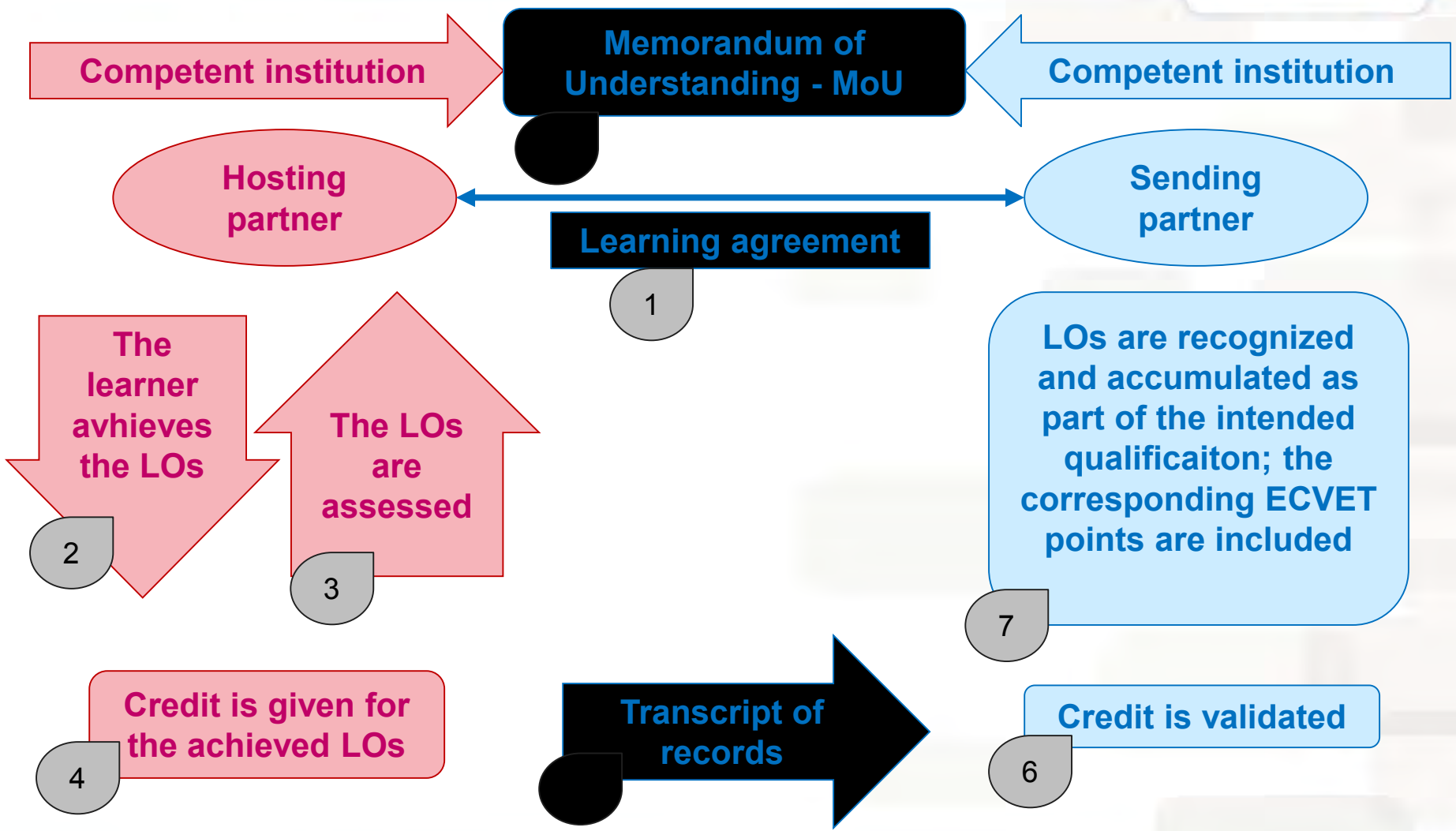

Feedback

Proposed modifications
on the MoU

Strategy definition

- Creation of partnership
- Identification of competent institutions
- Elaboration of MoU
- Establishment of MUTUAL TRUST

Partnership
Quality

Assessment

Of the partnership
(according, among
others, to the
quantitative criteria)

Implementation

- LAs (potentially many)
- Assessment
- PT
- Actual mobility takes place

14 National Agencies

Translate core principles and technical specifications into
PRACTICAL PROCESSES and TOOLS

www.ecvet-toolkit.eu

Online platform of tools, examples, information and resources to support mobility practices. (templates, checklists, examples...)

Chapters on ECVET Preparation, Partnership Building and Quality Assurance. Users can also work systematically through the steps associated with the planning, implementation and follow-up of ECVET in Geographical Mobility (Before Mobility, During Mobility and After Mobility).

NETECVET TOOL KIT



ecvet

European Credit system for
Vocational Education & Training

[home](#) | [about](#) | [user guide](#) | [sitemap](#) A A A

search...



introduction
to ecvet

Introduction to ECVET and
Geographical Mobility



ecvet
toolkit

Support for integrating ECVET into
new or existing Mobility Practice



tools, examples
& more

Tools, Examples and Further
Reading to aid successful ECVET
Integration

Key Actions Checklist: What-Who-How-Documentation

| ECVET- related issues | Building Partnerships | ECVET Before Mobility | ECVET During Mobility | ECVET After Mobility | |
|-----------------------|---|---|--|--|--|
| What? | <ul style="list-style-type: none"> Building a Partnership for ECVET mobility. | <ul style="list-style-type: none"> Formalising a partnership for ECVET mobility. | <ul style="list-style-type: none"> Defining the conditions for the mobility of each individual learner. | <ul style="list-style-type: none"> Actual training period abroad. Assessing and documenting knowledge, skills and competence acquired by the mobile learner. | <ul style="list-style-type: none"> Verifying that all formal requirements, as well as the stipulations stated in the LA, have been met; Validating and recognising learners' credit. |
| How? | <ul style="list-style-type: none"> Identifying suitable partners abroad and exchanging information. Involving competent institutions in both the sending and receiving countries (national and international partners). Mapping the roles and responsibilities of each partner in the sending and receiving countries. | <ul style="list-style-type: none"> Analysing qualification(s) and learning opportunities abroad. Identifying (units of) learning outcomes to be acquired during mobility, agreeing on the assessment procedures and how learning achievements will be documented, specifying the roles of partners involved and under which conditions credits can be transferred (validation and recognition). | <ul style="list-style-type: none"> Preparing the LA including information about: <ul style="list-style-type: none"> Unit(s)/groups of learning outcomes the learner will achieve abroad. How and when these will be assessed. How the unit(s) will be recognised. | <ul style="list-style-type: none"> Learners participate in learning activities in the hosting organisation relevant to the unit(s) they are preparing. Learners demonstrate their achievement of the required learning outcomes in an assessment process as specified in the MoU/LA Assessment organisations document the assessment results. | <ul style="list-style-type: none"> Comparing the documentation of the learning outcomes assessed by the host organisation with what has been agreed in the LA. Awarding unit(s) or qualification. Implementing practical implications agreed beforehand (for example, the learner is exempted from certain learning activities, does not have to retake exams, or acquires... |



Memorandum of Understanding

Version 2013



'File code' of the Memorandum of Understanding (optional)

[(use where necessary)]

1. Objectives of the Memorandum of Understanding

The Memorandum of Understanding¹ (MoU) forms the framework for cooperation between the competent institutions. It aims to establish mutual trust between the partners. In this Memorandum of Understanding partner organisations mutually accept their respective criteria and procedures for quality assurance, assessment, validation and recognition of knowledge, skills and competence for the purpose of transferring credit.

Are other objectives
agreed on? Please tick as
appropriate

No

Yes – these are: *[(insert information)]*



| Design of ECVET elements | | | Use of ECVET for accumulation and Transfer | | | |
|--|--|---|--|---|--|---|
| (F1.1.) Description of qualifications in terms of units of learning outcomes | (F2) Link between units of learning outcomes and the formal or non-formal programme | (F3) Link between assessment/ validation processes, the achievement of units of learning outcomes and award of associated ECVET points | (F4) Practical use of learning outcomes and credit for mobility | (F5.1.) Establishment of Learning agreements (F5.2.) Assessment of learning outcomes and award of corresponding credit | (F6.1.) Recording of assessed learning outcomes and credit in the personal transcript (F6.2.) Validation of learning outcomes and of corresponding credit Award of corresponding ECVET points to the learner | (F7) Recognition of learning outcomes and process for taking credit into account for the award of qualification (i.e. transfer and accumulation) |
| Transversal functions | | | | | | |
| (F8) Establishment of Memoranda of Understanding (all actors may be involved in establishment of a MoU directly or by delegation) | | | | | | |
| (F9) Provision of Information, its Documentation and Communication | | | | | | |
| (F10) Funding and governance | | | | | | |

Q4: Competent bodies



- What are the competent bodies for your country?



MoU: NETINVET experience

Presentation networks



- Networks presentation participants

Role-play

Building networks (**THIERRY FLOW**)



- Build a network (45 + 15 feedback)
- Agreement Hosting - Sending
 - Who should be involved?
 - What would be the main purpose?
 - What kind of agreements are needed?
 - How to guarantee the quality?
 - 4 groups – 2 focus sending – 2 focus groups
 - France / ? Choose their Q
 - Romany / ?

Role-play

Building networks



- Build a network
- Agreement Hosting - Sending
 - Who should be involved?
 - What would be the key objective?
 - What kind of agreements are needed?
 - How to guarantee the quality?





European
Commission

The ECVET qualification in the nuclear energy sector

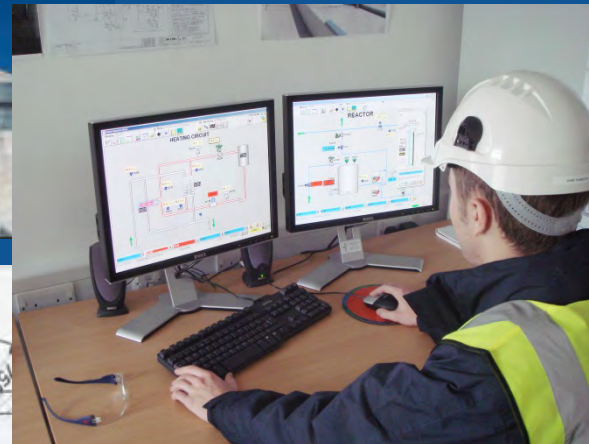



- Job oriented and academic qualifications



- From competences to learning outcomes



- ECVET in the nuclear energy sector

• Job oriented and academic qualifications



- ECVET promotes the implementation of tools to facilitate the cross-border recognition and the mobility of learners and professionals.
- It proposes also a change in the paradigm of how training and learning are conceived.
- The process of obtaining a qualification becomes more flexible and broadens in time and space.



Job oriented and academic qualifications

Qualification

(a)[...] **formal outcome** (certificate, diploma or title) of an assessment and validation process which is obtained when a competent body determines that an individual has achieved learning outcomes to given standards and/or possesses the necessary competence to do a job in a specific area of work.

Education system



Labour market

(b) **job requirements**: knowledge, aptitudes and skills required to perform specific tasks attached to a particular work position.



(c) **personal attributes**: the sum of knowledge, know-how, skills and/or competences acquired by an individual in formal, non-formal and/or informal settings.

Learner / employee





New approaches to learning

- *input-focused > output-focused*
- *Teacher/programme centred > learner centred*
- *Content (knowledge) based > Competence based*

The ECVET Qualification

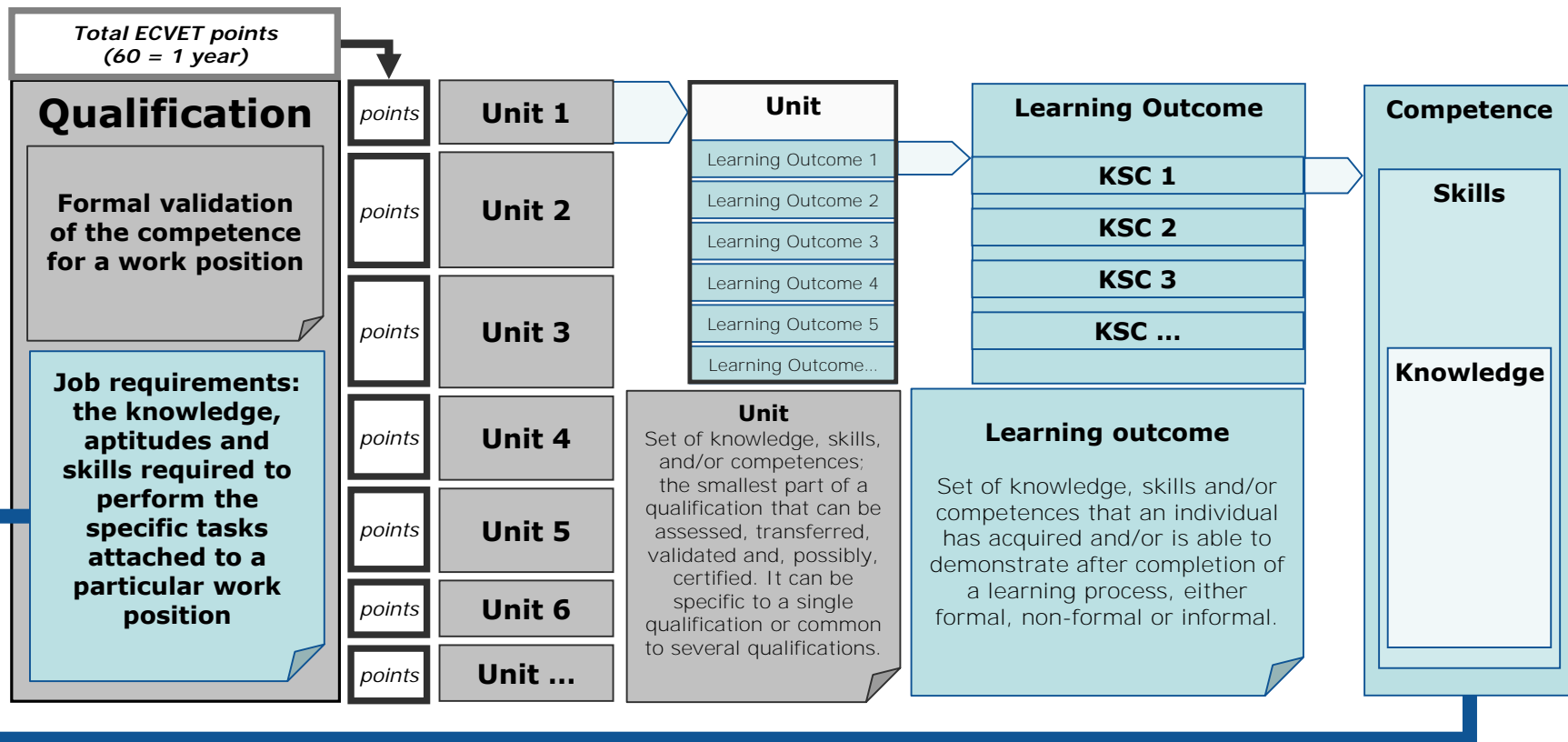

Definitions from: <http://europass.cedefop.europa.eu/en/education-and-training-glossary>



Competence typology

Knowledge: *The facts, feelings or experiences known by a person or a group of people*
[EQF]

Skill: *The knowledge and experience needed to perform a specific task or job* [EQF]

Competence: *Competence includes: i) cognitive competence involving the use of theory and concepts, as well as informal tacit knowledge gained experientially; ii) functional competence (skills or knowhow), those things that a person should be able to do when they are functioning in a given area of work, learning or social activity; iii) personal competence involving knowing how to conduct oneself in a specific situation; and iv) ethical competence involving the possession of certain personal and professional values.* [TWG ECVET]

[EQF] Commission of the European Communities, Commission Staff Working Document. Towards a European Qualifications Framework for Lifelong Learning, 2005

[TWG ECVET] European Credit System for VET (ECVET). Technical Specifications (Report 2005 of the Credit Transfer Technical Working Group)



Competence typology

| COMPETENCE | SKILLS | KNOWLEDGE |
|--|--|---|
| <i>In the context of EQF, competence is described in terms of responsibility and autonomy.</i> | <i>In the context of EQF, skills are described as cognitive (involving the use of logical, intuitive and creative thinking) and practical (involving manual dexterity and the use of methods, materials, tools and instruments).</i> | <i>In the context of EQF, knowledge is described as theoretical and/or factual.</i> |

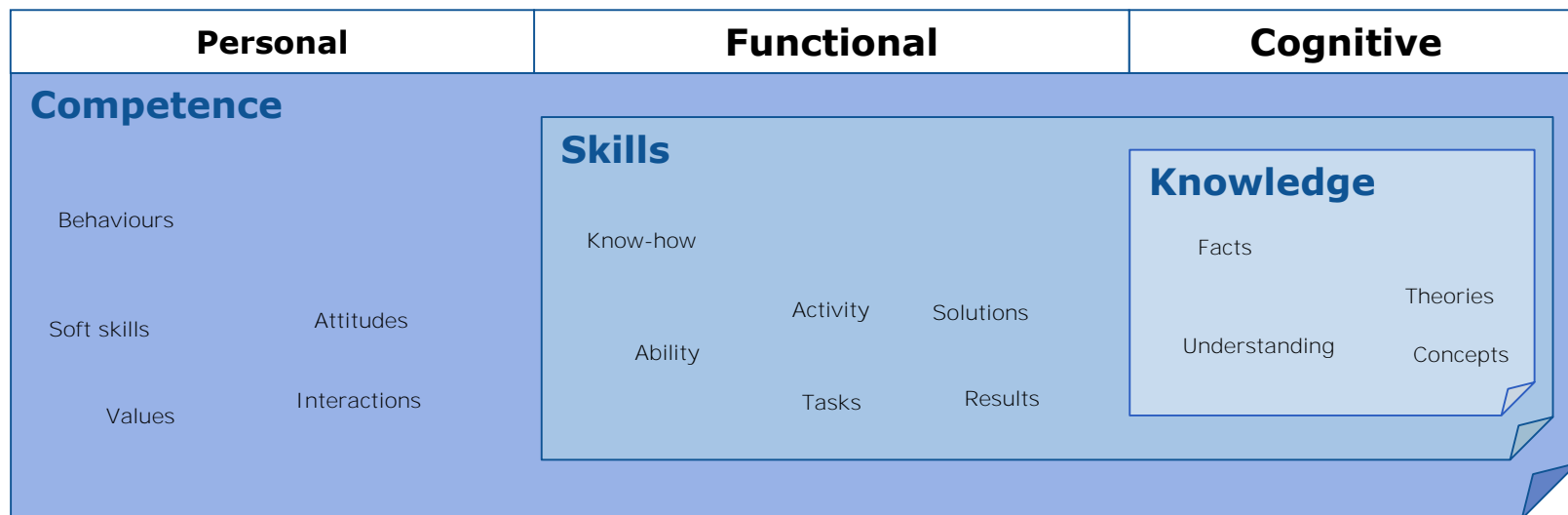

| | <i>personal</i> | <i>occupational</i> | |
|--------------------|--|--------------------------------|----------------------------------|
| <i>conceptual</i> | Meta-competence (facilitating learning) | | Cognitive competence (knowledge) |
| <i>operational</i> | Social competence (attitudes and behaviours) | Functional competence (skills) | |

Typology of knowledge, skills and competences: clarification of the concept and prototype, CEDEFOP 2005

LEARNING – EDUCATION – TRAINING

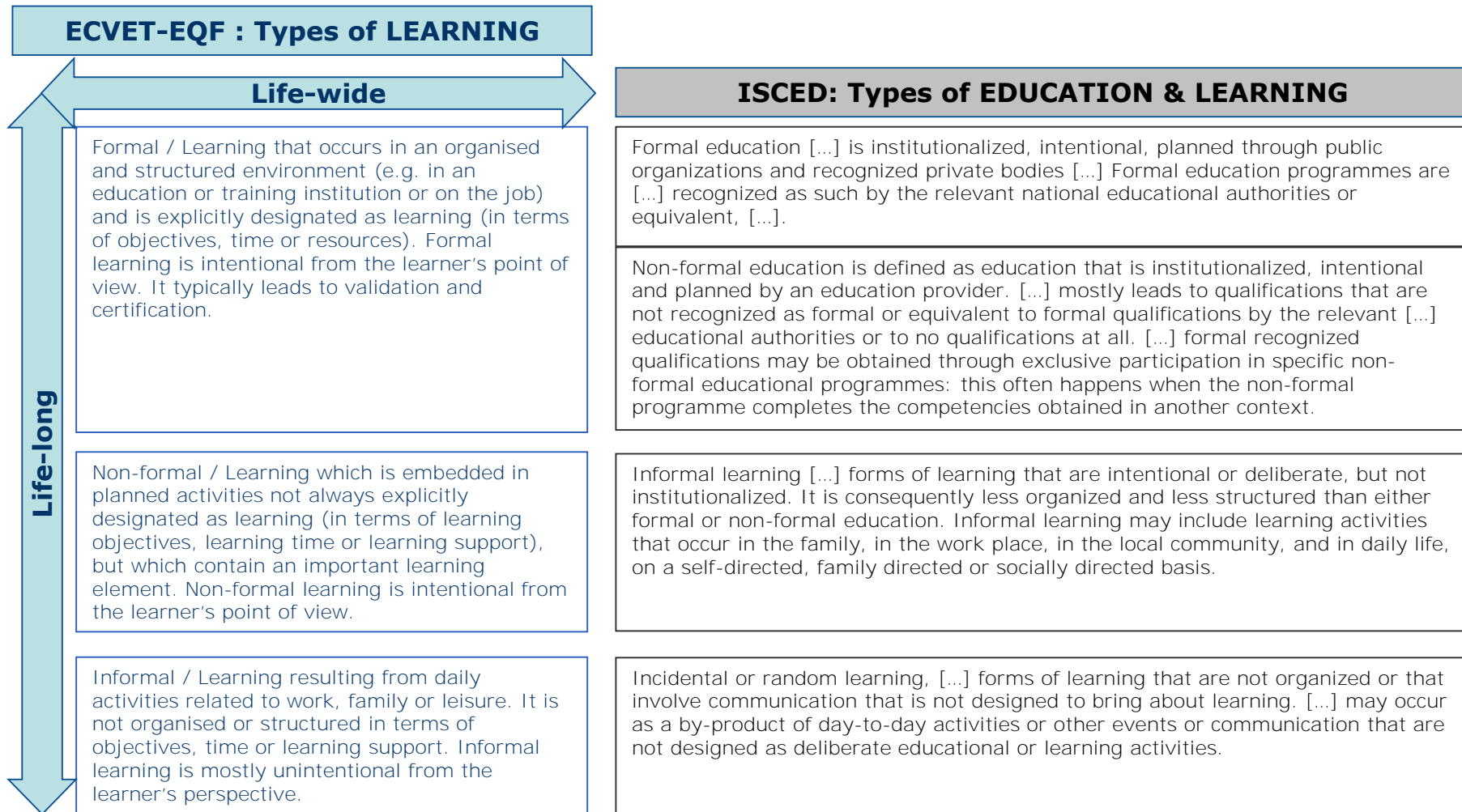



Job oriented and academic qualifications

The ECVET learning pathway

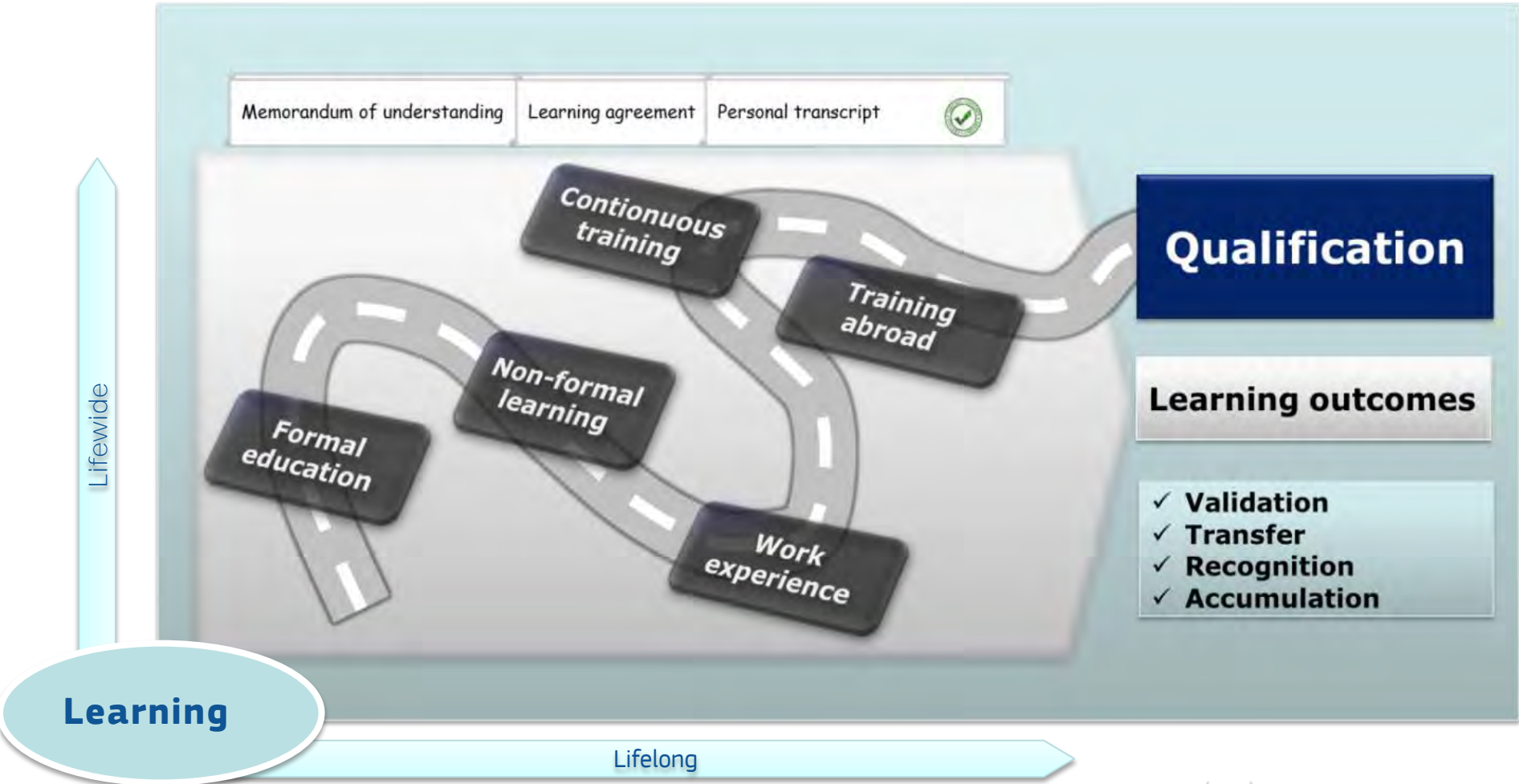



- *From learning outcomes to qualifications*

LEARNING OUTCOMES are statements of what a learner knows, understands and is able to do on completion of a learning process. The European definition of learning outcomes uses the terms of knowledge, skills and competence

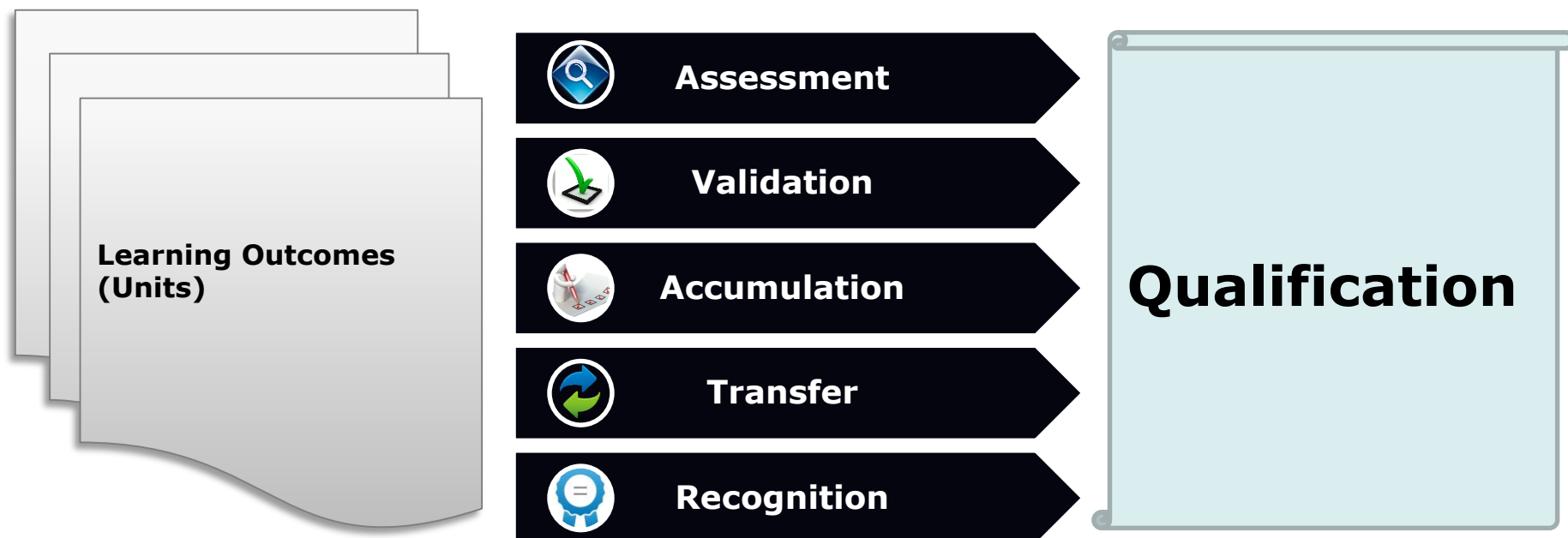



Job oriented and academic qualifications

- The benefits of ECVET

For individuals:

- Recognition of units and learning outcomes
- Easier mobility of students and employees
- Lifelong learning by means of flexible pathways to achieve qualifications

For E&T providers:

- Design programmes which are more relevant to industry
- More flexible and customised training schemes
- Transparent and comparable programmes
- Local and transnational cooperation between institutions

For Industry:

- Definition of job profiles in terms of competences
- Training better adapted to the needs of the sectors
- Better understanding of the qualifications
- Identify possible competence gaps in the sector



- From competence to learning outcomes



- The design of job-oriented qualifications begins with the definition of job profiles.
- It is necessary to identify the competences required to carry out a job position.
- The process to attain those necessary competences is described and assessed using **learning outcomes**.

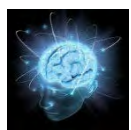

What are the learning outcomes?

Identify job positions

Qualifications

Determine roles,
functions and tasks

Units

Describe required
competences

Learning outcomes

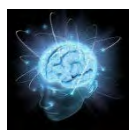

Identify key functions and roles

| Ref. | Job Title | Occupational Category |
|---|--|---------------------------|
| 2.2.02 | Senior Reactor Operator | Professional / Technician |
| Phase / Area | Alternate job title(s) – specialisations | Functional Category |
| NPP O | Head of Reactor Unit | Executive |
| Operations in Control Room | | |
| Role / Functions | | |
| <p>Responsible for all aspects of safe operation of reactor facility.</p> <ul style="list-style-type: none"> Ensures and controls the safe and trouble-free operation of reactor facility according to the requirements of technical specifications: (radiation situation, chemical regime, technological limits and conditions). Provides overall supervision of all activities in the operation of the reactor installation and its auxiliary systems and directly manipulate the controls of the equipment and systems. Monitors and controls the core, the reactivity and the systems, which can influence the reactivity. Ensures and controls the strict adherence to the requirements of nuclear safety and radiation protection in all activities related to the operation of the reactor installation. Reports to the Unit shift supervisor the operational condition of reactor facility or/and incidents occurred. Coordination of maintenance and testing activities and for a start-up of the equipment after maintenance Monitors parameters of assigned equipment during operations and ensure the response to system or unit abnormalities, diagnoses the cause, and recommends or applies corrective action and reports incidents. Responsible for recording and continuous update of operating registers. During the outage for refuelling, coordinates and monitors activities in the controlled area. In case of abnormal or emergency situation strictly adheres the instructions of the Unit Shift Supervisor in accordance with the Emergency Operating Procedures and the internal emergency plan. Interfacing with other departments of the organization in framework of his duties. Responsible for implementation of operational procedures such as those controlling start-up and shut-down activities, including periodic testing of relevant equipment. | | |



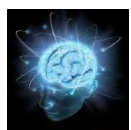

Defining job requirements

| JOB REQUIREMENTS | |
|--|-----------------|
| KNOWLEDGE (Cognitive competence) | EQF level (1-8) |
| Nuclear Engineering. | 6 |
| Nuclear operation: Nuclear unit systems operation: reactor start-up, normal, transient, emergency, Measurement of operating parameters, Power plant dynamics and control, Reactor core operation, Instrumentation and applications. | 6 |
| Operation experience | 6 |
| Occupational safety and personal protective equipment | 6 |
| Nuclear safety | 6 |
| Nuclear Science. | 5 |
| Emergency preparedness | 5 |
| Understanding of complex regulations and procedures | 5 |
| Using and interpreting engineering data and documentation | 5 |
| Applied Techniques and Engineering: General electrical engineering, Electric Power Generation, Electric power system operation, Electrical measurement instrumentation, Energy Conversion, General mechanical engineering, Sensors, Measurements, and Signal Processing; Instrumentation and control, Pipe systems, pumps and turbine, Hydraulic and pneumatic installations, Plant Chemistry. | 4-5 |
| Radiation protection and radiation monitoring | 4-5 |
| National and international regulations | 4 |
| Corporate procedures | 4 |
| Human error prevention techniques | 4 |
| Accident analysis and accident modelling | 4 |
| Risk assessment | 3 |
| Material Science | 3 |

KNOWLEDGE



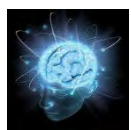

Defining job requirements

| SKILLS (Technical and functional competence) | EQF level (1-8) |
|--|-----------------|
| Perform operational and emergency plans and procedures | 6 |
| Transmit commands to coordinate the functioning of ancillary equipment | 6 |
| Operate and monitor computer-controlled equipment | 6 |
| Regulate working parameters using the information of recorders and displays | 6 |
| Verify condition of equipment using testing and measurement instrumentation | 5 |
| Prepare operational records technical reports on the analysis and tests | 5 |
| Execute correction of abnormal conditions according to standard practice and instructions received | 5 |
| Visual inspection | 4 |
| Comply with statutory regulations and organizational safety requirements | 4 |
| Providing input for the draft of requirements specifications, | 4 |
| Monitor and maintain a safe working environment | 4 |
| Operating computers using specific software | 4 |
| Provide input for preparing nuclear safety documentation | 4 |

SKILLS



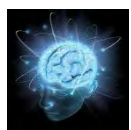

Defining job requirements

ATTITUDE



| COMPETENCE (Attitude; behavioural and personal competence) | EQF level (1-8) |
|--|-----------------|
| Communication - Ability to understand and be understood | 6 |
| Team working | 6 |
| Decisiveness | 5 |
| Stress resistance | 5 |
| Accountability | 5 |
| Capacity to act upon problems | 5 |
| Dealing with difficult situations | 5 |
| Multitasking | 5 |
| Safety culture | 5 |
| Supervision, monitoring and appraisal abilities | 4 |
| Intellectual / Problem solving and judgement skills | 4 |
| Problem solving | 4 |
| Corporate communication | 4 |
| Punctuality | 4 |
| Self-motivation | 4 |

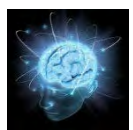

What are the learning outcomes?

- *Learning outcomes are statements of what a learner is expected to know, understand and/or be able to demonstrate after a completion of a process of learning*
- *Statements of what a learner can be expected to know, understand and/or do as a result of a learning experience*
- *Learning outcomes are statements that specify what a learner will know or be able to do as a result of a learning activity. Outcomes are usually expressed as knowledge, skills, or attitudes*
- *Specific measurable achievements. A learning outcome is a statement of what competences a student is expected to possess as a result of the learning process*



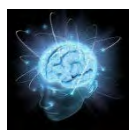

From competence to learning outcomes

Learning outcomes aim for a more transparent and clear description of the learning results

LOs are connected to the concept of competence, although there is no common understanding of the term

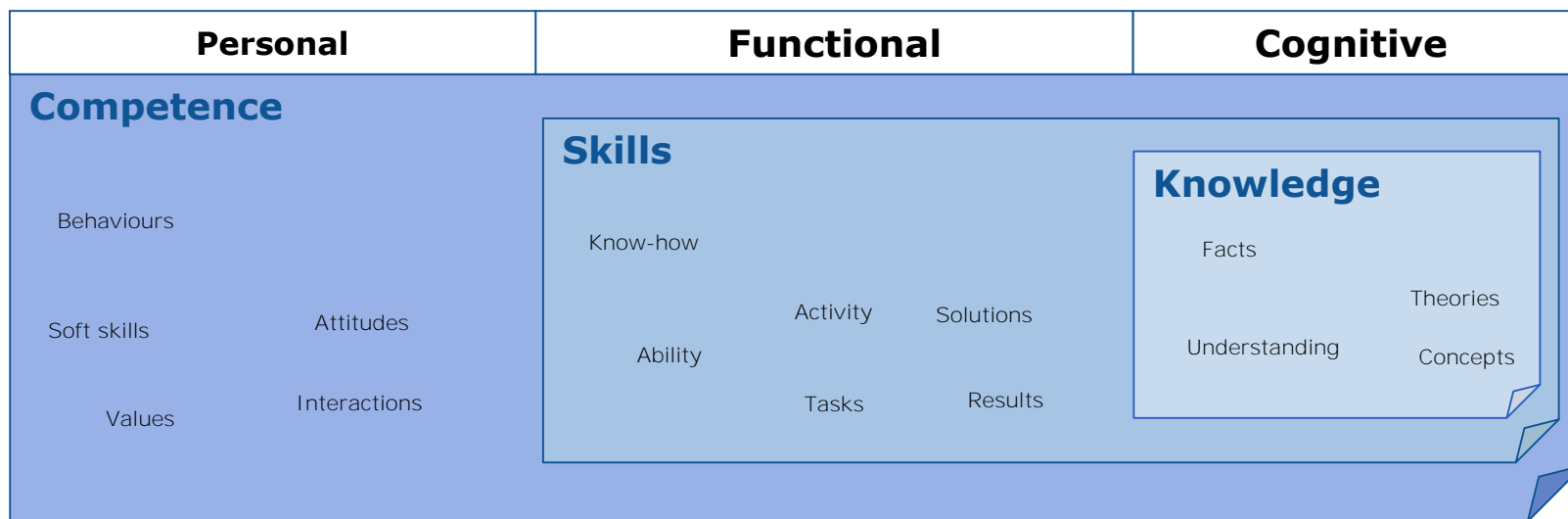



From competence to learning outcomes

- *Key competences (EU)*

- **Communication in the mother tongue**

- **Communication in a foreign language**

- **Mathematical literacy and basic competences in science and technology**

- **Digital competence**

- **Learning-to-learn**

- **Interpersonal and civic competences**

- **Entrepreneurship**

- **Cultural expression**



Recommendation 2006/962/EC of the European Parliament and of the Council of 18 December 2006 on key competences for lifelong learning

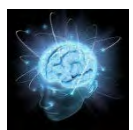

- *Key competences (OECD)*

- **CATEGORY 1. USING TOOLS INTERACTIVELY**

The ability to use language, symbols and text interactively

The ability to use knowledge and information interactively

The ability to use technology interactively

- **CATEGORY 2. INTERACTING IN HETEROGENEOUS GROUPS**

The ability to relate well to others

The ability to cooperate

The ability to manage and resolve conflicts

- **CATEGORY 3: ACTING AUTONOMOUSLY**

The ability to act within the big picture

The ability to form and conduct life plans and personal projects

The ability to assert rights, interests, limits and needs

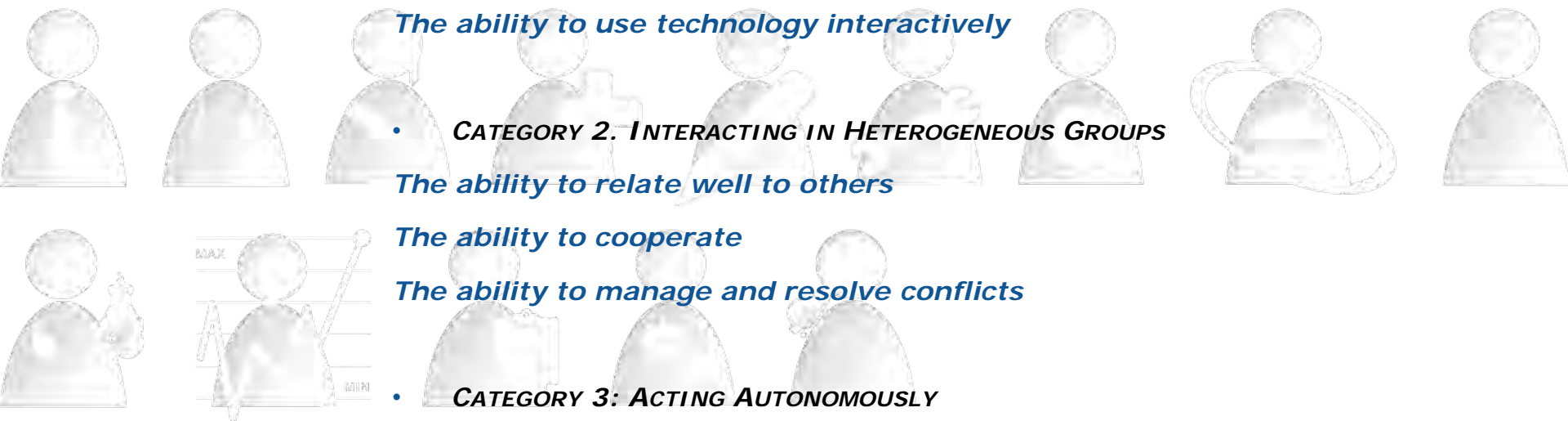

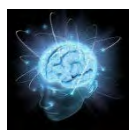

From competence to learning outcomes

- Competence typology applied to the definition of job requirements

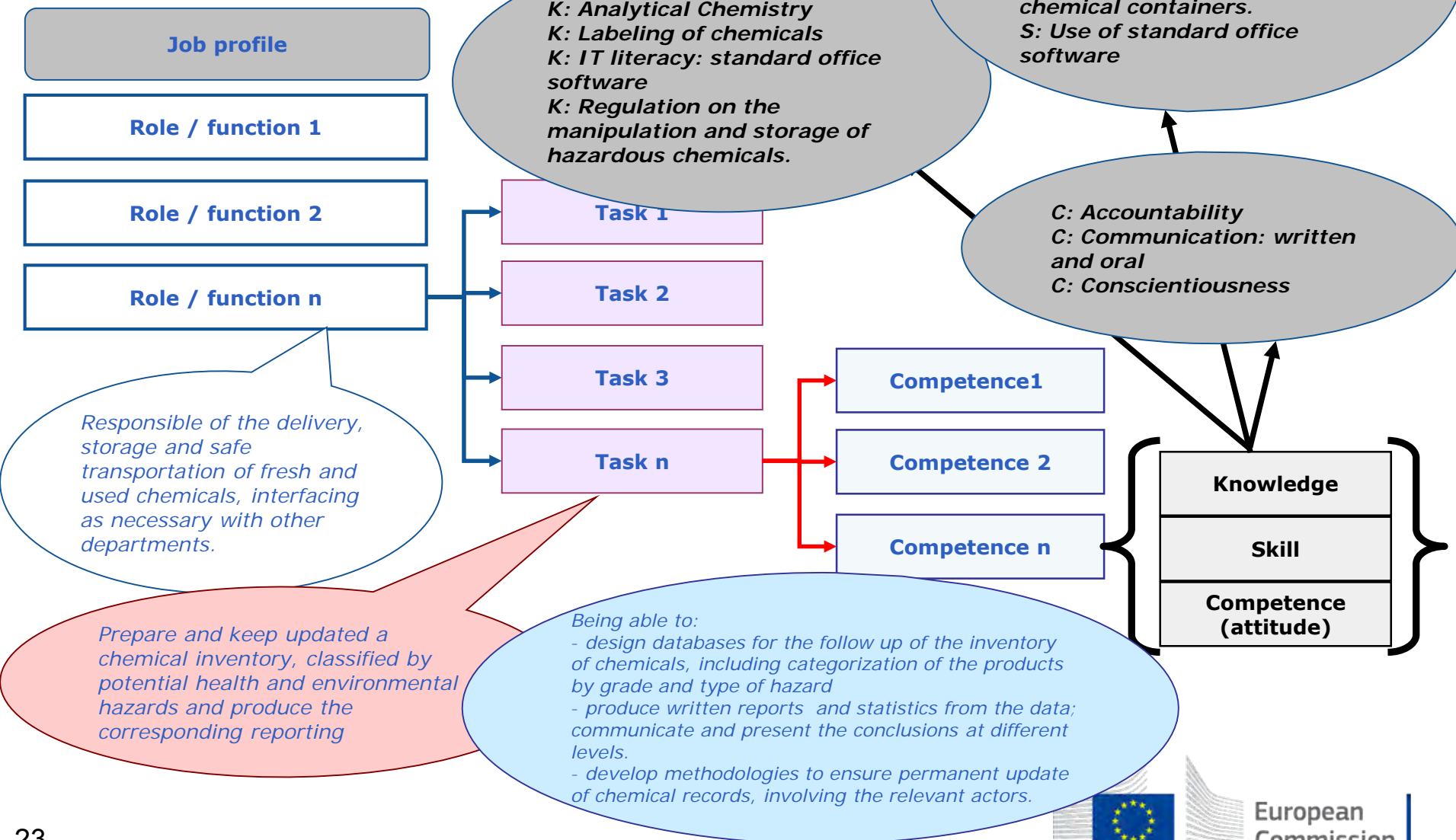

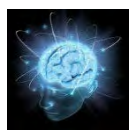

From competence to learning outcomes

- *How to formulate learning outcomes*

Learning outcomes have three parts

- *Active verb*
- *The content, task, or object of the learning*
- *The criterion, context or purpose to fulfil*



But there is not one only “right” way to write LOs

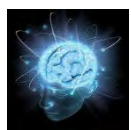

- *How to formulate learning outcomes*

| ACTION WORD (performance) | LEARNING STATEMENT (the learning) | CRITERION (the conditions of the performance demonstration) |
|------------------------------|---|--|
| Applies | ALARA principles | for the preparation of procedures and work instructions |
| Produces | technical documentation on plant modifications | following the applicable procedures |
| Performs | preventive maintenance of electromechanical equipment | according to given schedules and specifications |

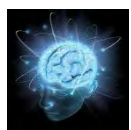

Advantages and disadvantages of LOs

- *More precise description of units and programmes*
- *Transparency and comparability*
- *Confidence of students, training providers and employers*
- *Flexible pathways between national systems and between vocational and tertiary*
- *Prescriptive and limiting for the learning process*
- *Unsuitable for academic higher education*
- *Huge effort investment*
- *Diminish the role of the teacher*
- *Imperfect coverage of the subjects*



Pros and cons of learning outcomes



- The nuclear energy sector "case"



The nuclear energy sector has specific traits to be taken into account when considering human resources, education and training, and competence management.



The nuclear energy sector "case"

What's different about nuclear?

Workforce
shortage

Relevance of
safety and
security

Regulatory
requirements

Transnational
mobility

Others?



The nuclear energy sector "case"

Specific barriers

Permeability and comparability with ECTS

Overlying licensing requirements

Non-transferable competences

Corporate barriers on mobility

Competence-based approach



The nuclear energy sector "case"

Potential benefits

- **Access of learners to expertise and facilities**
- **Bringing closer labour force and demand**
- ***Nuclearisation* and update of competence**
- **Better use of existing competence**
- **Learning of integrated competence**

Mobility (learners and professionals)

Transfer and recognition

Individual learning pathways

Assessment and validation

Shift to learning outcomes



The nuclear energy sector "case"

What are the barriers for the implementation of ECVET in the nuclear sector



Discussion time





3rd ECVET Seminar – customized for Nuclear Energy Sector

Introduction of the national NUC-VET networks



3rd ECVET Seminar for NES

Main objective

To assist support the national NUC-VET networks in setting up an ECVET pilot project/
NUC-VET PP

New & complex problems

Study case: Qualification upgrade from CRO to Shift Supervisor

- initial requirements: CRO (**Secondary studies/EQF5**); Shift Supervisor (**Tertiary studies/ EQF6**)

- new problems to be solved:

- a) to "**invent/develop**" pathways between VET/ **EQF 5** & higher edu./ **EQF 6**
- b) "**invent/develop**" methods of validation & recognition of K,S,C acquired by NA&IL

National NUC-VET networks

NUC-VET PP partnership

National NUC-VET networks ideally encompassing:

- ✓ Industry: NPP, RadWaste facility, other type of nuclear facilities
- ✓ National Administration (competent for qualification accredit.)
- ✓ Regulatory body – TSO
- ✓ E&T providers

3rd ECVET Seminar for NES

Main objective

New & complex problems

National NUC-VET networks

To support the national
NUC-VET networks
in setting up an ECVET
pilot project/
NUC-VET PP



3rd ECVET Seminar for NES

Main objective

New & complex problems

European NUC-VET networks

To assist support the national NUC-VET networks in setting up an ECVET pilot project/
NUC-VET PP



European NUC-VET networks

Petrus III

B. BAZARGAN
SABET

ENETRAP III

Th. BERKVENS

ENEN

P. PORRAS
DIEGUES

Introducing European NUC-VET networks:

- Number of partners
- Partners' profile
- Current activities
- Possible application for an PP

3rd ECVET Seminar for NES

Main objective

New & complex problems

National NUC-VET networks

To assist support the national NUC-VET networks in setting up an ECVET pilot project/
NUC-VET PP



Introducing national NUC-VET networks:

- Number of partners
- Partners' profile
- Current activities
- Possible application for an PP

National NUC-VET networks

| | |
|----------|------------------------|
| Austria | A. HEFNER |
| Bulgaria | L. PYRONKOV; M. ILIEVA |
| France | P. LIVOLSI |
| Germany | M. KUGLSTATTER |
| Italy | G. CONSTANTINI |
| Romania | O. COMSA; G.L. PAVEL |
| Spain | J. IGLESIAS MORAM |

ECVET for the Nuclear Energy Sector

ENETRAP III NUC-VET Network

Thomas Berkvens
Project collaborator
SCK•CEN Academy for Nuclear Science and Technology
tberkven@sckcen.be

Third ECVET seminar for the nuclear energy sector
Rome, 12-14 November 2014



- 7FP, Fission-2012-5.1.1: Euratom Fission Training Schemes (EFTS) in 'Nuclear Fission, Safety and Radiation Protection', project number 605159
- 01/06/2014, 4 years
- 780.000 euro contribution from EC
- 13 partners + consultancy group (advisory board)
- <http://enetrap3.sckcen.be/>



| Participant Organisation Name | Profile | Country |
|--------------------------------------|-------------------------|-----------------|
| SCK•CEN | Research / E&T | Belgium |
| PHE | Governmental | United Kingdom |
| Bfs | Governmental | Germany |
| CEA-INSTN | Research / E&T | France |
| KIT | Research / E&T | Germany |
| CIEMAT | Research / E&T | Spain |
| NRG | Research | The Netherlands |
| EFOMP | Professional federation | United Kingdom |
| EUTERP | E&T / foundation | The Netherlands |
| IST-ID | Higher education | Portugal |
| BME | Higher education | Hungary |
| PGE SA | Industry | Poland |
| Université de Lorraine (UL) | Higher education | France |



Objectives linked to ECVET

- **Build and maintain** an advanced level of competence in RP
- Further develop the **European reference training scheme** with additional specialized modules for **Radiation Protection Experts** working in medical, geological disposal and NPP + Train-the-trainer event
- Implement **ECVET** principles
- **Demonstrate the practical feasibility** of earlier developed concepts for **mutual recognition**



PETRUS III

Implementing sustainable
E&T programmes in the
field of Radioactive Waste
Disposal



| N° | Participant organisation name | Country |
|-----------|--------------------------------------|----------------|
| 1 | (UL) | France |
| 2 | (POSIVA) | Finland |
| 3 | (ENEN) | France |
| 4 | (EMN) | France |
| 5 | (CU) | United Kingdom |
| 6 | (LNU) | Sweden |
| 7 | (MICANS) | Sweden |
| 8 | (RAWRA) | Czech republic |
| 9 | (ARAO) | Slovenia |
| 10 | (ENRESA) | Spain |
| 11 | (Aalto) | Finland |
| 12 | (UPM) | Spain |
| 13 | (CTU) | Czech republic |
| 14 | (UPB) | Romania |
| 15 | (CEA) | France |
| 16 | (IST-ID) | Portugal |
| 17 | (TU Delft) | Netherlands |
| 18 | (SCK.CEN) | Belgium |
| 19 | (CIRTEN) | Italia |
| 20 | (REC) | Slovenia |
| 21 | (Nidia) | Italia |



Ireland



United Kingdom



Netherlands



Belgium

Luxembourg



France



Portugal



Spain



Italy



Slovenia

Austria

Czech Republic



Slovakia

Poland

Denmark



Sweden



Finland

Estonia

Latvia

Lithuania



Romania

Bulgaria

Greece

Malta

Cyprus

Work package 1

Elaboration of the PD training programme using ECVET model

The objective of this work-package is to use the “**European Credit system for Vocational Education and Training**” (ECVET) principles and to develop “competence-based” curriculum for the elaboration of the radioactive waste disposal Professional Development training programme that will be accredited for qualification at academic Master’s level in WP2.

Work package 2

Actual implementation of the PD training programme

The objective of the WP2 is to implement the PETRUS training programme at least in one of the partner universities as a pathway for the obtainment of a Master degree with recognition agreements from other partners.

As part of an inter-institution agreement the creation of portfolios of learning outcomes expressed in terms of knowledge, skills and competences (KSC) will serve as a basis for the proposed "European Passport of Professional Competences".

Obstacles

- Construction of the programmes - Comparability in curricula construction
- Difference in extent and content of training programmes
- Difference of systems (curriculum based systems and competence based systems)
- Different systems of valuation in the VET systems - Diversity of systems
- Differences regarding normative aspects of work performance
- Absence of standardised units in the process
- Lack of common standards/training criteria
- Lack of agreed procedures at international level
- Absence of competences' assessment methodology
- Outcomes' evaluation methods
- Lack of a system for designing learning outcomes in relation to competences
- Comparability of competences

Application of ECVET System

Harmonisation of the European qualification systems: Expected after 2012

- For the PETRUS PD programme we adopt existing national systems which are close to the general “philosophy” of the ECVET system
- We apply most of the ECVET principles for building the accreditation structure

Principle of modularity

- Training programme is divided into a number of “*units*”
- Each unit encompasses a certain number of “*credit points*”

Qualification = Completion of the total number of units

Learners can accumulate credit points in different countries, and in different learning situations (e.g. modular courses, practical training, academic or non-academic training providers)

Principle of partnership

- Partnership agreements or memoranda of understanding (MoU) between accreditation institution and providers.
- **Recognition** of the quality of courses, assessment procedures and validation processes.

The key point of the MoU is that the learning outcomes for which credits are awarded by one or the other of the partners can be recognised irrefutably.

Principle of learning agreement

- Draw up an individual learning agreement for each applicant.
- This document would notably specify the learning outcomes expected at the completion of units and the associated points of credit. This individual learning agreement should be drawn up between the applicant and the accreditation institution.
- Employer could be also associated.

PETRUS Professional Development Programme

Steps in building training programme

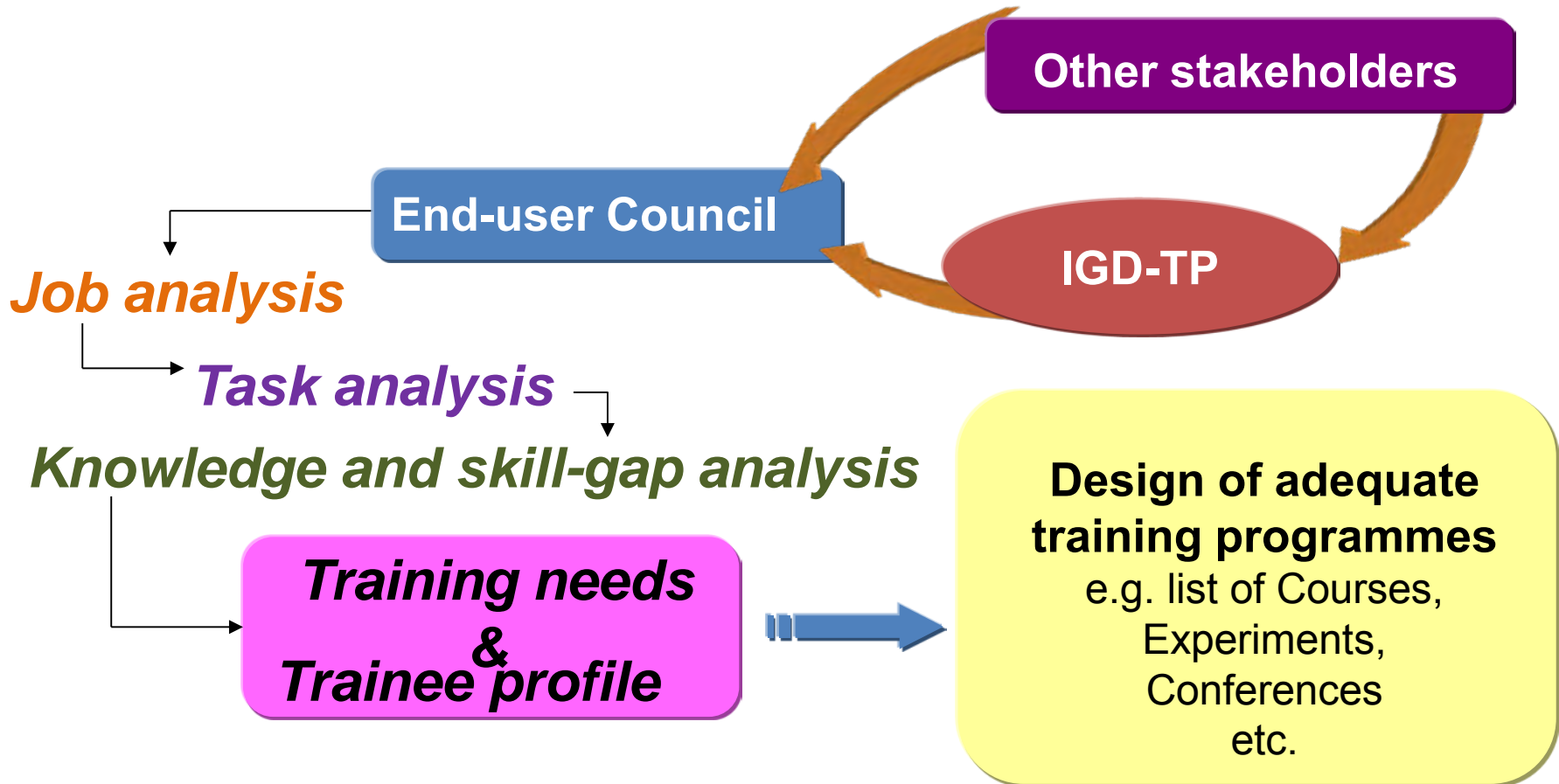

Example of a Job Context and Training Scheme

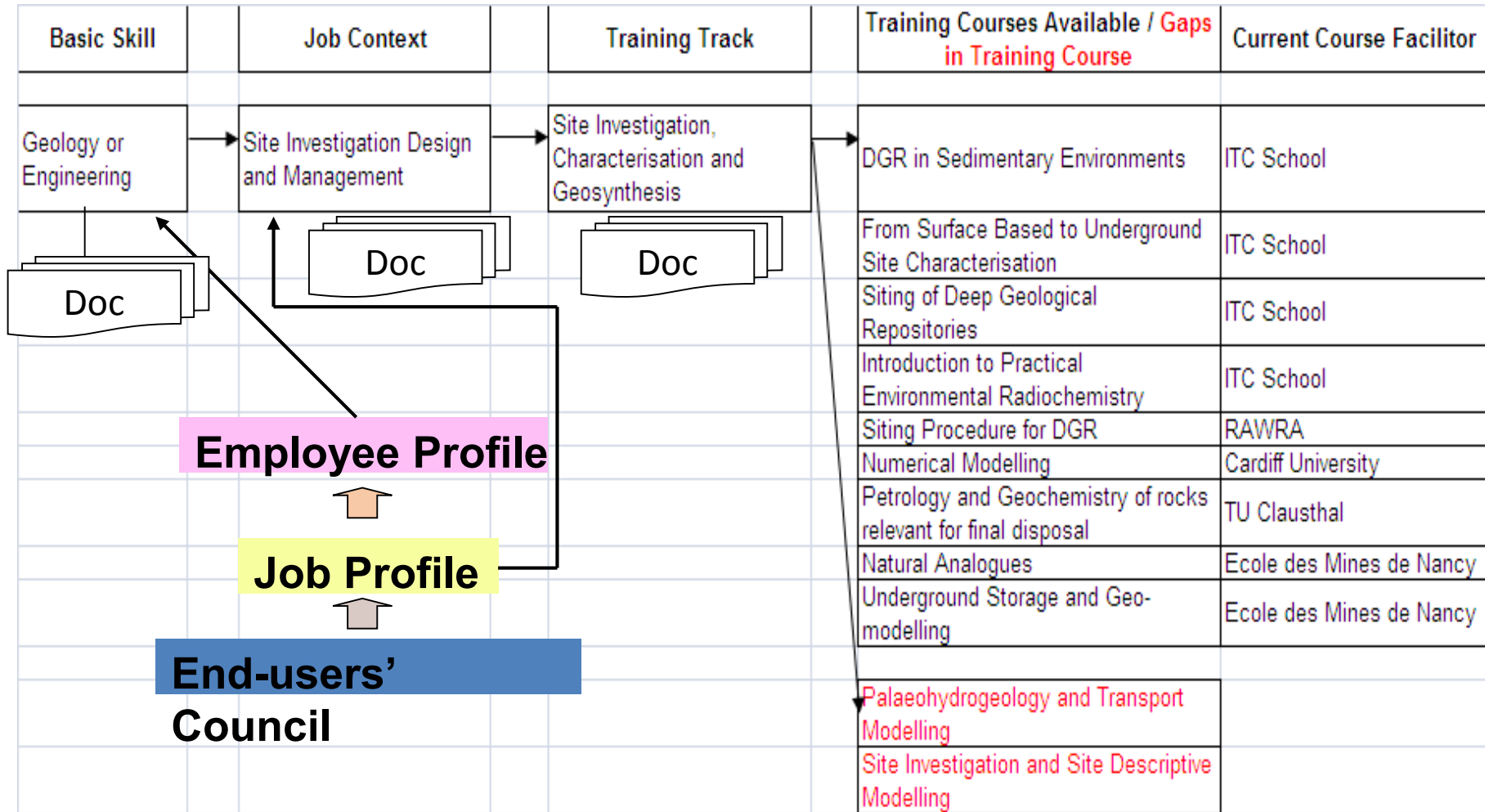

Certification by steps

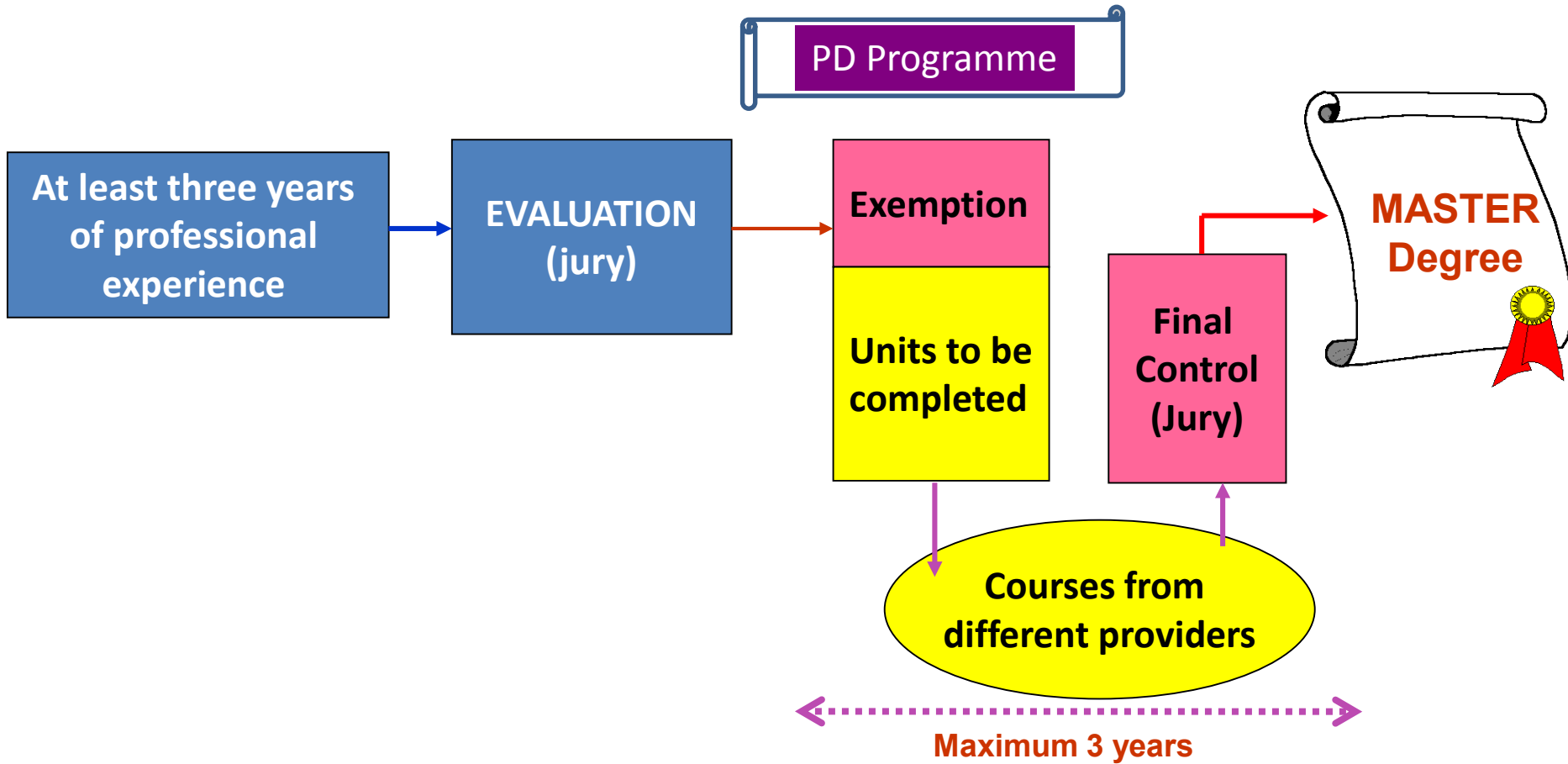

Example of qualification process in Professional Development using ECVET instrument

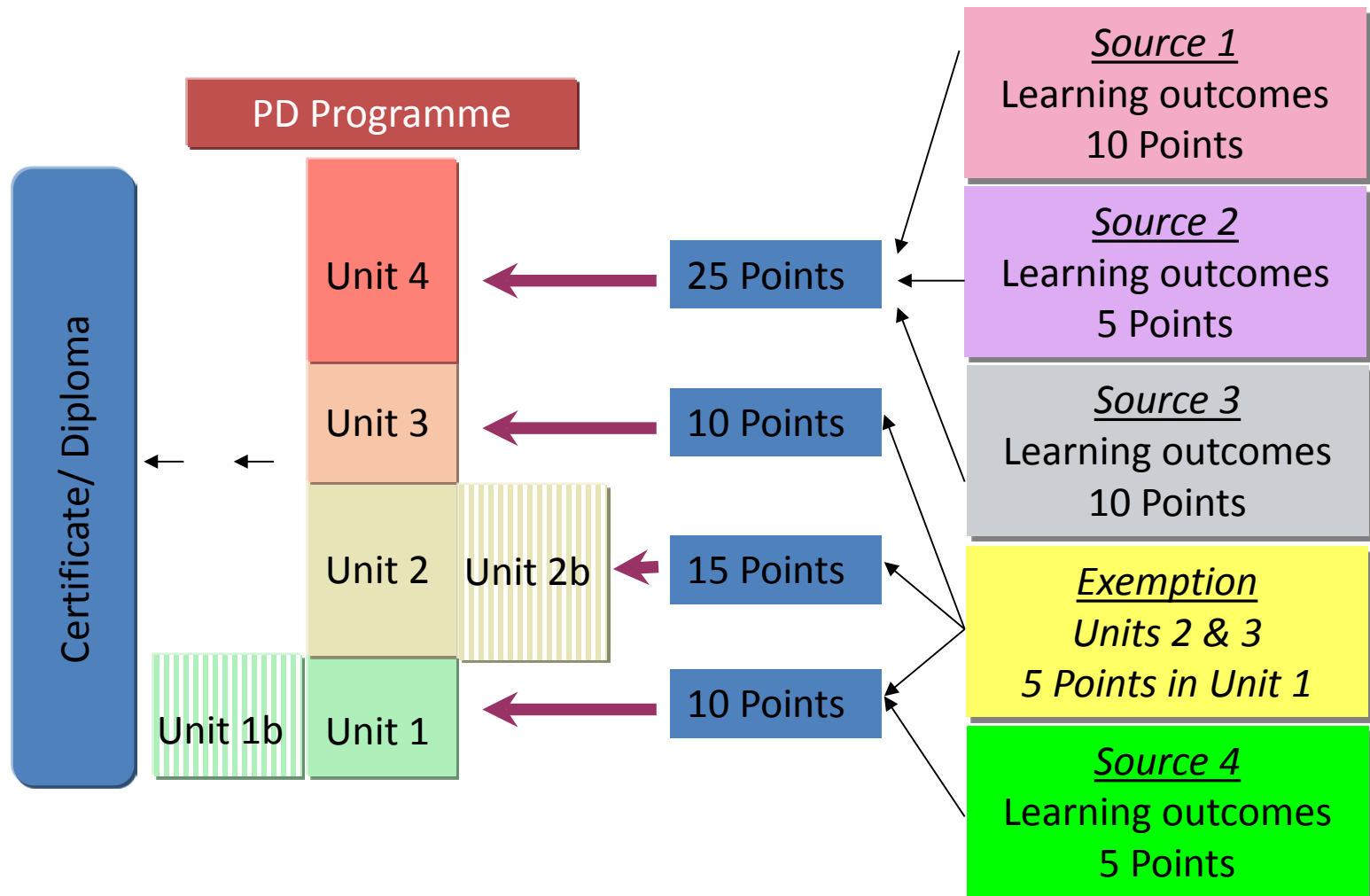

Evaluation of PETRUS PD programme

Heterogeneity → Is training equally beneficial for all participants?

"customer satisfaction" effectiveness and usefulness

1st step: Trainee profile

2nd step: Trainees' feedback

3rd step: knowledge evaluation

4th step: transfer evaluation

5th step: outcomes evaluation

Validity & Reliability

PD Curriculum improvement

Pre-Test

Post-Test

Formative
summative

TOTEM
Model*

Brinkerhoff
"SCM" model

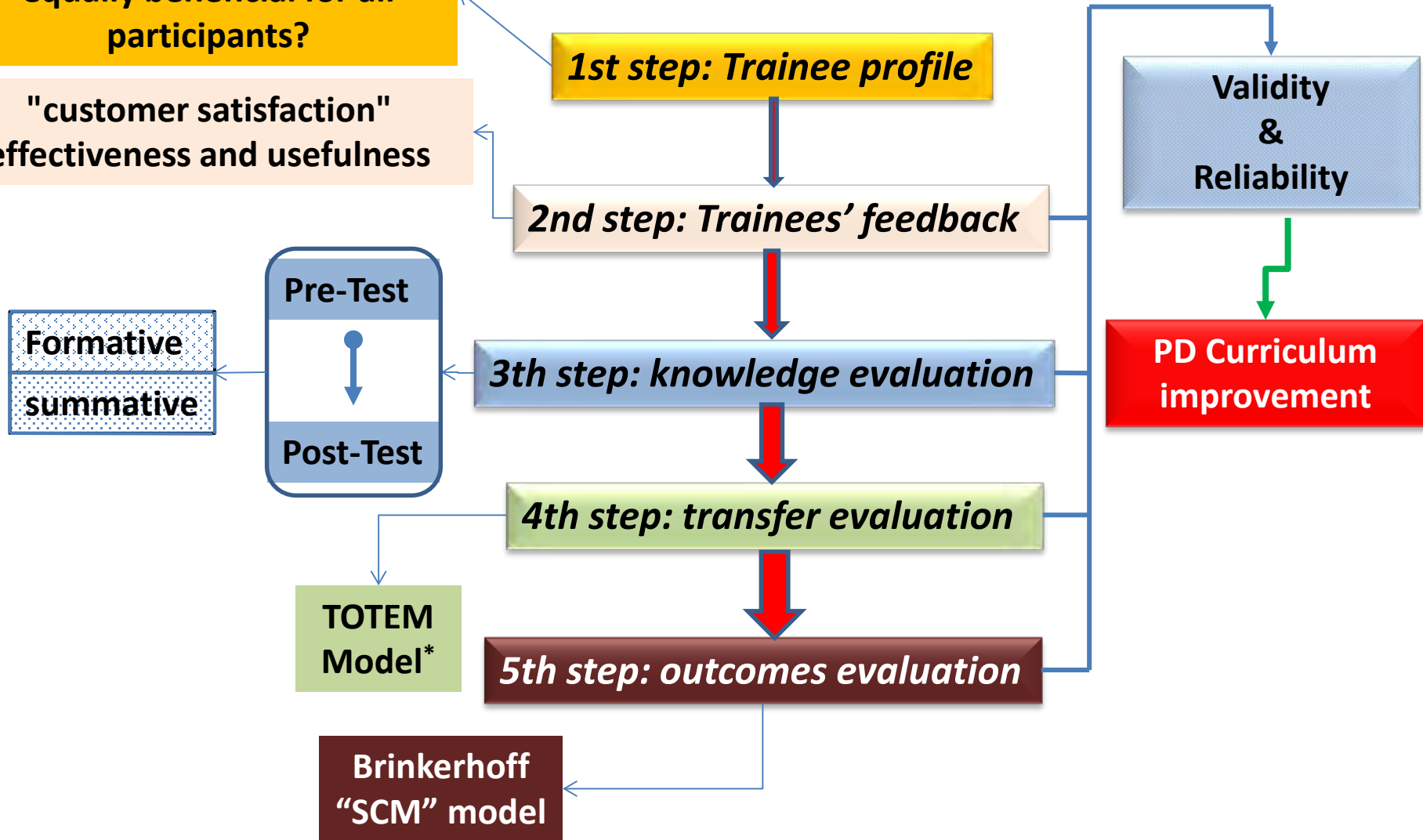
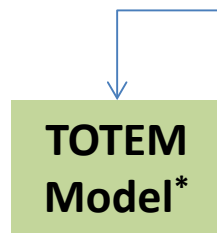
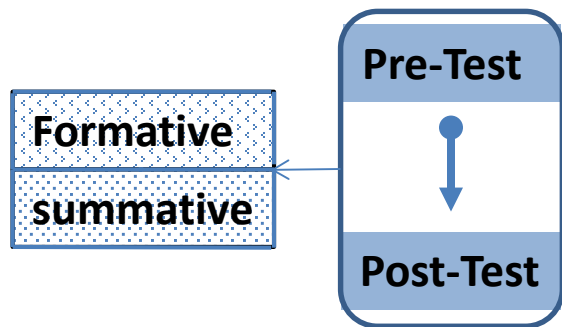



The ENEN Association and its missions

*3rd ECVET Seminar for the Nuclear Energy Sector
Hotel Nord Nuova Roma, Rome (Italy)
12 - 14 November 2014*

Walter Ambrosini and Pedro Diezuez Porras

President and Secretary General of ENEN



How ENEN began

THE FP5 ENEN PROJECT

European Commission – EURATOM
5th Framework programme

ENEN project in January 2002 – December 2003

Following declarations and policies on phasing out nuclear power plants, nuclear sciences and disciplines are facing:

- *decreasing interest and a reduced numbers of students*
- *no successors for retiring professors*
- *discontinuing nuclear related courses and closing faculties*

The “European Nuclear Engineering Network” project:

- *established the basis for conserving nuclear knowledge and expertise*
- *created a European Higher Education Area for nuclear disciplines*
- *facilitated the implementation of the Bologna declaration in the nuclear disciplines*



THE FOUNDATION

In order to ensure the continuity of the achievements and results of the ENEN project :

“The European Higher Education Area” in the nuclear field is formalised by creating the

European Nuclear **Education** Network, the “ENEN”

Association under the French law of 1901, on **22nd of**

September 2003.



THE OBJECTIVES

The main objective is the preservation and further development of expertise in the nuclear fields by *higher* education and training

- Promote and further develop the collaboration in nuclear education and training of students, researchers and professionals
- Ensure the quality of nuclear education and training
- Increase the attractiveness for engagement in the nuclear fields for students, researchers and professionals
- Promote life-long learning and career development at post-graduate or equivalent level

ENEN Members

List of ENEN Members

LIST OF ENEN MEMBERS (55 + 9 = 64 MEMBERS AS OF 1 MARCH 2013)

| | | |
|--|-----------|---------------------------|
| Atominstitut der Oesterreichischen Universitaeten | ATI | Vienna, Austria |
| Katholieke Universiteit Leuven | KUL | Leuven, Belgium |
| Université Catholique de Louvain | UCL | Louvain-la-Neuve, Belgium |
| Ghent University | UG | Ghent, Belgium |
| Université de Liège | ULG | Liege, Belgium |
| Université Libre de Bruxelles | ULB | Brussels, Belgium |
| Vrije Universiteit Brussel | VUB | Brussels, Belgium |
| Belgian Nuclear Research Centre | SCK•CEN | Mol, Belgium |
| Westinghouse Electric Company | WES | Brussels, Belgium |
| Czech Technical University in Prague | CTU | Prague, Czech |
| CV Rez, a.s. | CVR | Prague, Czech |
| Aalto University School of Science and Technology | AALTO | Helsinki, Finland |
| Lappeenranta University of Technology | LUT | Lappeenranta, Finland |
| CEA/INSTN Centre d'Etudes de Saclay | CEA/INSTN | Saclay, France |
| Institut National Polytechnique de Grenoble | INPG | Grenoble, France |
| Ecole des Mines de Nantes | EMN | Nantes, France |
| AREVA | AREVA | Paris, France |
| Centre National de la Recherche Scientifique | CNRS | Paris, France |
| Institut Régional Universitaire Polytechnique | IRUP | Saint Etienne, France |
| Institut Supérieur des Techniques de la Performance | ISTP | Saint Etienne, France |
| Technische Universitaet Muenchen | TUM | Munich, Germany |
| Universitaet Stuttgart | IKE | Stuttgart, Germany |
| Institute of Nuclear Fuel Cycle, RWT Aachen University | INBK | Aachen, Germany |
| Karlsruhe Institute of Technology | KIT | Karlsruhe, Germany |
| J. W. Goethe Universität | IAPFU | Frankfurt, Germany |
| Ruhr Universität Bochum | RUBLEE | Bochum, Germany |

ENEN Members

Institute for Safety and Reliability
Aristoteles University
Budapest University of Technology and Economics
Consorzio Interuniversitario per la Ricerca Tecnologica
Nucleare
SOGIN
Delft University of Technology
AGH-University of Science and Technology
University Politecnica Bucharest
National Institute "Horia Hulubei"
Slovak University of Technology in Bratislava
University of Ljubljana
Jozef Stefan Institute
Universidad Politecnica de Madrid
Technical University of Catalonia - Barcelona Tech
Universidad Nacional de Educacion a Distancia

ISAR Munich, Germany
AUTH Thessaloniki, Greece
BME Budapest, Hungary
CIRTEN Pisa, Italy
SOGIN Rome, Italy
DUT Delft, The Netherlands
AGH Krakow, Poland
UPB Bucharest, Romania
IFIN-HH Bucharest, Romania
STU Bratislava, Slovakia
UL Ljubljana, Slovenia
JSI Ljubljana, Slovenia
UPM Madrid, Spain
UPC Barcelona, Spain
UNED Madrid, Spain

TECNATOM

Uppsala Universitet
Royal Institute of Technology
Chalmers University of Technology
Swiss Federal Institute of Technology Zürich
Swiss Federal Institute of Technology Lausanne
University of Manchester
University of Birmingham
Imperial College London
University of Hertfordshire
University of Central Lancashire

TECNATOM San Sebastián de los Reyes-Madrid,
Spain
UU Uppsala, Sweden
KTH Stockholm, Sweden
CUT Goteborg, Sweden
ETH Zurich, Switzerland
EPFL Lausanne, Switzerland
UM Manchester, UK
UB Birmingham, UK
ICL London, UK
UH Hatfield, UK
UCLAN Preston, UK

ENEN Members

By concluding a Memorandum of understanding, the following Partners are considered as an ENEN Member, without a Voting right at the General Assembly.

| | | |
|---|-----------|-----------------------------|
| Joint Research Centre of the European Commission | JRC | |
| North West University | NWU | Potchefstroom, South Africa |
| Moscow Engineering Physics Institute (State University) | MEPhI | Moscow, Russia |
| Central Institute for Continuing Educaiton and Training | CICET | Obninsk, Russia |
| Tokyo Institute of Technology | TokyoTech | Tokyo, Japan |
| University of Fukui | FUKUI | Fukui, Japan |
| Japan Atomic Energy Agency | JAEA | Tokai, Japan |
| V. N. Karazin Kharkiv Naitonal University | KKNU | Kharkiv, Ukraine |
| Odessa National Polytechnic University | ONPU | Odessa, Ukraine |

LIST OF MOU PARTNERS (4 PARTNERS AS OF 1 MARCH 2013)

| | | |
|---|-------|-------------------|
| European Nuclear Society | ENS | Brussels, Belgium |
| International Atomic Energy Agency | IAEA | Vienna, Austria |
| University Network of Excellence in Nuclear Engineering | UNENE | Canada |
| World Nuclear University | WNU | UK |

All these institutions benefit at different extents of the existence of ENEN and of its actions

THE ENEN ASSOCIATION

The European Nuclear Education Network is

*a non-profit international organization established on
22 September 2003 under the French Law of 1901*

*Its mission is the preservation and further development of expertise
in the nuclear fields by higher education and training through:*

- promotion of networking for education and training in Europe
- favouring borderless mobility of students and teachers
- providing attractiveness for young and motivated students
- leading relevant EU Projects for E&T and R&D among which EFTS
- qualifying itself as a reference institution for the cross-cutting issue of E&T in the nuclear fields: a “bridge” academia ↔ stakeholders

ACTIVITIES RELATED TO ECVET

Coordination of the EU ENEN III Project

Training schemes for 4 kinds of Nuclear Engineers:

- Non-nuclear engineers operating in the nuclear field
- Generation III Design Engineers
- Generation III Construction Engineers
- Generation IV Conceptual Design Engineers

Key role of AREVA in the project

Generation III and IV engineers: addressing mainly the nuclear systems suppliers (May 2009 – April 2013) – ***Use of ECVET system***

Thank you for your attention !

European Nuclear Education Network Association
Centre CEA de Saclay – INSTN – Bldg 395
F-91191 Gif-sur-Yvette Cedex, France

Tel ☎ +33 1 69 08 97 57
Fax +33 1 69 08 99 50
E-mail sec.enen@cea.fr

www.enen-assoc.org

RO-NUVET

Olivia COMSA

CITON-Center of Technology and Engineering for Nuclear Projects

comsao@router.citon.ro; olivia.comsa@gmail.com

Gabriel PAVEL

UPB-Politechnica University of Bucharest

gabriel.pavel@gmail.com

RO-NUVET Partners

- ANDR- National Agency & Radioactive Waste
- CNCAN-National Commission for Nuclear Activities Control
- RATEN-CITON-Center of Technology and Engineering for Nuclear Projects
- SNN-Cernavoda NPP-Training Centre
- IFIN-HH Training Centre
- UPB-Politechnical University of Bucharest
- UB-University of Bucharest
- UBB=Babes Bolyai University Cluj
- UPIT-University of Pitesti
- “Ovidius” University Constanta
- CNDIPT-National Centre for TVET Development

ANDR-National Agency & Radioactive Waste

www.nuclearagency.ro

- **Mission**

- **Providing specialized technical assistance to the Government in the process of developing and adopting policies to promote, develop and monitor the power and non-power applications of nuclear energy in exclusive peaceful purposes, safe disposal of radioactive waste and to coordinate, at national level, the process of radioactive waste management and the decommissioning of nuclear installations.**

- **Functions**

- **strategy, which ensures the development and updating of the National Strategy for the Development of the Nuclear Field and of the National Nuclear Programme (NNP)**

CNCAN- *National Commission for Nuclear Activities Control*

www.cncan.ro

- The National Commission for Nuclear Activities Control (CNCAN) is the national authority, having responsibilities of regulation authorization and control in nuclear field in Romania as:
 - **Legislation and regulations in the field of safe deployment of nuclear activities in Romania**
 - **Nuclear safety**
 - **Radiation protection**
 - **Quality management in nuclear field**
 - **Safeguards**
 - **Emergency plans for intervention in case of nuclear or radiological accident**
 - **Physical protection of nuclear installations and objectives**
 - **Radioactive waste management**
 - **Authorization of operating personnel**
 - **International treaties and conventions**
 - **Harmonization of national legislation from nuclear field with similar legislation and regulations of the European Union**
 - **Fulfillment of Romania's accession to EU requirements on nuclear safety, radiation protection and safeguards**

Contact: Madalina TRONEA madalina.tronea@cncan.ro

3.RATEN-TECHNOLOGIES for NUCLEAR ENERGY STATE OWNED COMPANY www.citon.ro;www.nuclear.ro;www.raten.ro

- RATEN is a Romanian legal entity under the authority of the Department for Energy of the Ministry of Economy. RATEN is organized and acts as a national strategic State Owned Company, following the juridical rules of this type of organization and accordingly to the normative acts governing the research activities in the nuclear field having two subsidiaries:
- Institute for Nuclear Research Pitesti, RATEN ICN;
- Center of Technology and Engineering for Nuclear Projects, Bucuresti Magurele, RATEN CITON.

CITON-Center of Technology and Engineering for Nuclear Projects

www.citon.ro

- Strategic institute performing scientific research, design, engineering and technological development
- Scientific and technical responsibility for the development of nuclear energy in Romania
- Designer of Cernavoda NPP and NFC Industry
- Training for design, engineering and technological jobs

- Contact:
- Olivia COMSA comsao@router.citon.ro
- Sorin Meglea :megleas@router.citon.ro

ICN-Nuclear Research Institute

www.nuclear.ro

- **"Sustainable Development through Nuclear Research and Education"**
- Performs scientific research, fundamental and applied technological development, technology transfer, design, investments, consultancy, expertise and technical specialized assistance
- Triga research reactor as a training tool
- Ensure scientific and technical support for Romania's nuclear energy sector.
- Contact: Ilie TURCU ilie.turcu@nuclear.ro

Cernavoda NPP-Nuclear training Centre

www.nuclearlectrica.ro;www.cne.ro

Nuclear training division:

SIMULATOR

OPERATING TRAINING

GENERALS & SKILLS TRAINING

PROGRAMS COORDINATING

ORIENTATION &

AUTHORIZATION TRAINING

Contact:tiron@cne.ro



Nuclear training Simulator



Cernavoda NPP MCR Unit 1



Romanian Nuclear Activities-MoU Nuclearelectrica and CNNC Cernavoda NPP Units3&4



IFIN-HH Nuclear Training Center

www.cpsdn.nipne.ro



- The training center has an experience of more than 40 years in providing training programs in fields as:
- Radiological Safety in use of sealed/unsealed radiation sources,
- Radiation Safety in Industrial Radiography,
- Radiation safety in mining and processing of uranium and thorium ores,
- Radiation Protection in Diagnostic and Interventional Radiology,
- Radiation Protection in Nuclear Medicine,
- Radiological Safety in Radiotherapy
- training programs are approved by Romanian Regulatory Body (CNCAN)
- Contact: stanescu@nipne.ro

UPB-Politechnical University of Bucharest

www.upb.ro



- Member of the ENEN, ENEN-II, ENEN-III, NEPTUNO, TRASNUSAFE, EURECA!, ENEN-RU, EUJEP, NEWLANCER, ARCADIA, RONEN, consortia on Education and Training

Complete educational program:

- BSc in(only nuclear related topics): Nuclear Processes, Nuclear Physics, Radiation Protection, Nuclear Materials, NPP, Nuclear Engineering, Nuclear Safety, Nuclear Installation Reliability, Nuclear Legislation, Non-power production use of Nuclear Technologies
- MSc “Nuclear Engineering” ;
- PhD

University of Bucharest-FACULTY OF PHYSICS

<http://www.fizica.unibuc.ro/>



Engineering Physics(BSc), as “Nuclear Reactors and Nuclear Materials”
Medical Physics (BSc, MD)-within Radioisotopes

Environmental science(MD), within “Nuclear Energy. Fuel cycles and reprocessing”

General Physics – Nuclear Physics, Radioprotection and Dosimetry

Contact: Prof.Octavian DULIU octavian.o.duliu@upcmail.ro

BABES –BOLYAI University Cluj- Napoca

<http://phys.ubbcluj.ro/>



- Member of the Ro-TERP and TENSP consortia on Education and Training
- Engineering Physics(BSc), as “Nuclear Reactors and Nuclear Materials”
- Medical Physics (BSc, MD)-within Radioisotopes
- Environmental science(MD), within “Nuclear Energy. Fuel cycles and reprocessing”
- Chemical Engineering(BSc) – within Radiochemistry
- General Physics – Nuclear Physics, Radioprotection and Dosimetry
- Contact: Prof.Radu-Decebal Ciurchea dr.ciurchea@academic.ro

RO-NUVET E&T Network- University of Pitesti



RO-NUVET Network-Ovidius University Constanta

<http://www.univ-ovidius.ro/>



RO-NUVET Network

- History:
- TENSP-<http://www.academic.ro/tensp>

Romanian National Consortium

Training and Education in Nuclear Sciences Platform

- RONEN-www.ronen.ro

Romanian Nuclear Education and Training Network

- RONUVET-www.ronen.ro

RO-NUVET E&T Network

2

- Introduction of the European/national NUVET (E&T) networks: partners, motivation and expectations;
 - Proposals from the European/national NUVET (E&T) networks on:
 - âˆš possible qualifications to be tested in an ECVET project;
 - âˆš specific cases of learners' mobility to implement in an ECVET project;
 - âˆš project partners from abroad.
 - Outline of the pilot project: national/international networks involved; role of each partner; activities and expected outcomes;
 - The PPT presentations have to be sent to the organizers before 1st of November 2014.



The way forward





12
NOV
2014

14
NOV
2014

Rome (IT)

The 3rd ECVET Seminar
customized for nuclear energy
sector

Updated Agenda



- 09.00 Welcome / introduction Day 2
- 09.10 National networks
- 09.40 Assessment / mutual trust
- 09.50 WS Mutual Trust
- 11.00 Coffee break
- 11.20 ECVET Mobility
- 11.35 MoU, LA, ECVET toolbox
- 11.55 Netinvest
- 12.15 Lunch

Sector Skills Alliances

Sector Skills Alliances

A Commission initiative designed to promote European cooperation within specific sectors of the economy. SSAs develop vocational skills from the perspective of labour market needs, ensuring cooperation between education and employment.

> ec.europa.eu/education/events/2014/20140415-sector-skills_en.htm

- Sector Skills Alliances will work to design and deliver joint vocational training programmes and teaching and training methodologies. A particular focus is to be put on work-based learning, providing learners with the skills required by the labour market.
- Each Sector Skills Alliance shall implement a coherent, comprehensive and variable set of interconnected activities, such as:
 - Defining skills and training provision needs in a given specific economic sector.
 - Designing joint curricula.
 - Delivering joint curricula.

Partners

1. Public or private entities that provide VET

(such as: networks of vocational education institutes/schools; VET centres; inter-company training centres; enterprises that have more than 250 employees and with an own training department, in particular those providing apprenticeships or enterprises providing shared training (collaborative training); higher education institutions providing VET)

2. Public or private entities that have sector specific expertise and are representative for/in commerce sector (at regional, national or European level)

(such as: social partners; European sectoral or professional associations of employers or employees; chambers of commerce, of industry or of skilled crafts; cultural and creative bodies; skills bodies or councils; economic development agencies; research centres).

3. Public or private entities that have a regulatory function for education and training systems (at local, regional or national level)

(such as: public VET authorities; accreditation, certification or qualification bodies; bodies responsible for recognition; bodies providing career guidance, professional counselling and information services)



Assessment & mutual trust

Moving between general and vocational education ('permeability')

In qualification systems, qualifications at EQF level 4 are frequently used to test ECVET. Level 4 is a 'traditional' vocational qualification level, even though ECVET is expected to cover all levels of EQF.

In higher education, ECTS is another credit transfer system established to ease credit transfers between higher education institutions and developed in the Bologna process framework. It is primarily and to a large extent based on inputs such as course length and number of hours.

While for the moment ECTS and ECVET are developed separately, bridges between the two systems would also ease permeability between vocational and other qualifications. Current attempts to define ECTS in terms of learning outcomes may be a step in supporting their convergence.

ECVET and ECTS

- A systematic dialogue between VET and higher education is needed and this is where the relationship ECVET-ECTS has to be addressed
- This dialogue should address how the two credit transfer systems can interact to facilitate transfer and recognition
- This dialogue must address the political as well as technical conditions for transfer and recognition
- Need a focus on the learner (moving upwards, downwards and sideways) - the credit systems are instruments, not aims in themselves

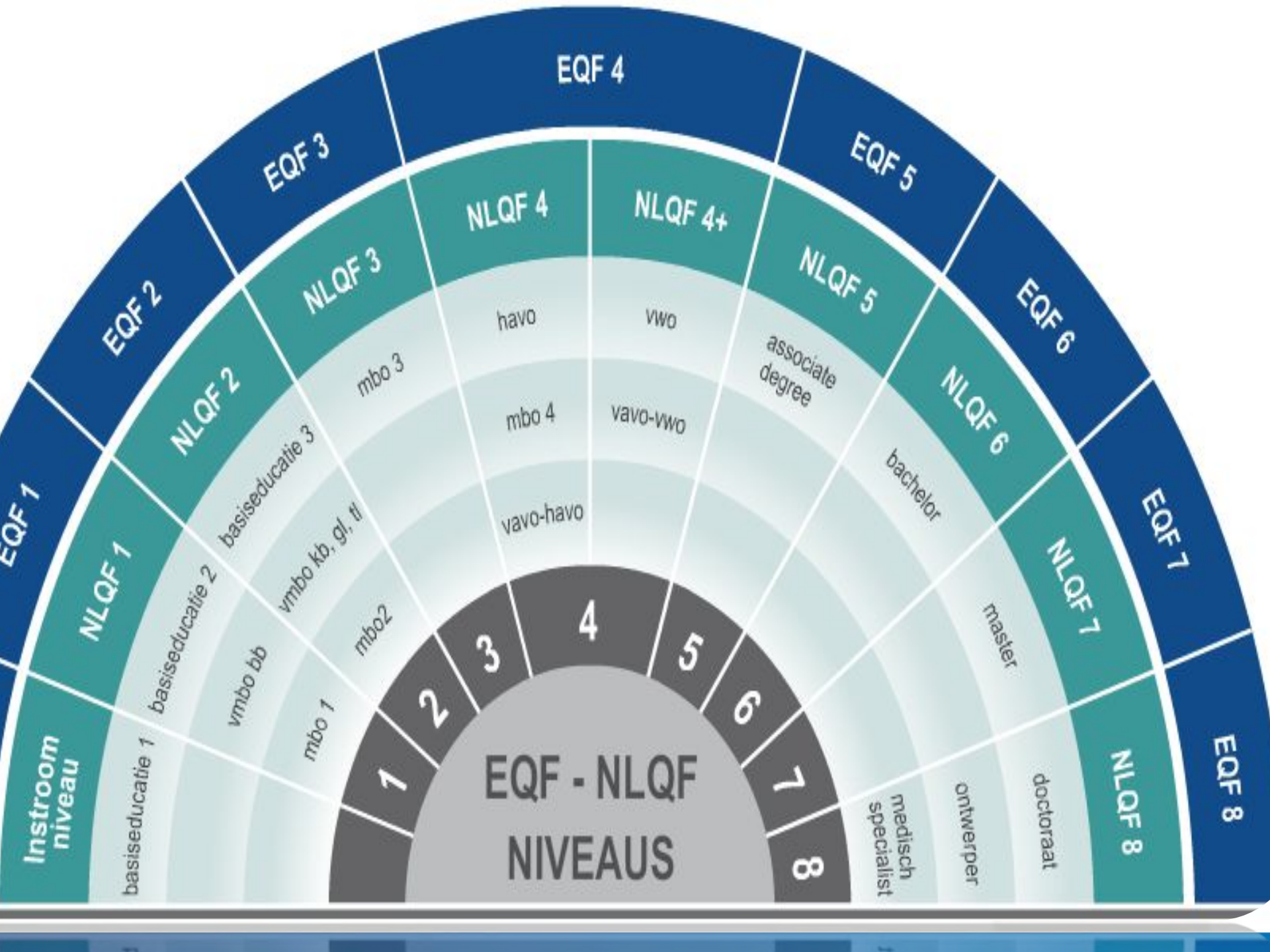

EQF -NQF



| Qualification | NLQF level | EQF level | Date classification | Expiration date | Owner |
|-------------------------------------|------------|-----------|---------------------|-----------------|-------------------------|
| Royal Marechaussee Security Officer | 2 | 2 | 15-02-2013 | 15-02-2018 | LOKKMar |
| General Law Enforcement Officer | 3 | 3 | 09-04-2013 | 09-04-2018 | LOKKMar |
| Dog trimmer | 3 | 3 | 19-09-2013 | 19-09-2018 | Honden Kennis Instituut |
| Psychosocial Consultant | 6 | 6 | 19-09-2013 | 19-09-2018 | Psychodidact |
| Stressmanagement Coach | 6 | 6 | 19-09-2013 | 19-09-2018 | Psychodidact |
| Relation manager companies ABN AMRO | 6 | 6 | 19-09-2013 | 19-09-2013 | ABN AMRO |

The development of ECVET in Europe



 **CEDEFOP** | European Centre for the Development
of Vocational Training

WORKING PAPER

No 22

Monitoring ECVET
implementation
strategies in Europe
in 2013

CEDEFOP

- Survey of 38 countries/regions
- National VET contexts: presence of units/modules, transfer and accumulation possibilities
- Perceived added-value
- Status of policy making – is there a policy decision to use ECVET in reforming VET systems

■ Challenges – what works, what doesn't

- More time to understand whether and/or how ECVET may be implemented in the national VET systems
- More clarity of purposes, and streamlining on the basis of what works or does not work in practice
- Acknowledgement that ECVET is a toolbox or concept, rather than a system containing technical specifications



The country clusters

Cluster I: countries with units/modules and credit systems

ES, FI, IE (all CAS, excluding apprenticeship), IS, LU, RO, SE, SI, UK.

Cluster II: countries with units/modules and no credit systems

BE-DE, EE, FR (all qualifications of the Ministry of Education), HR, HU, NL, PL, PT, RS, TR.

Cluster III: countries without units/modules and predominantly apprenticeship-based IVET

AT, CH, DE, DK, LI, NO.

Cluster IV: countries without units/modules and predominantly school-based IVET

BE-FL, BE-FR, BG, CY, CZ, EL, IT, LT, LV, ME, MK, MT, SK.

ECVET supports greater flexibility within systems



- ECVET can support lifelong learning as a reference model for reforms to make VET systems more flexible, in particular by **organising qualifications into certified units of learning outcomes**, which facilitate accumulation and transfer of credit, usually in convergence with national qualification frameworks (NQF).
- This is shown by national experiences such as those, mentioned above, in the French Community of Belgium, Finland or Malta.

ECVET support the quality of geographic mobility



- ECVET supports cross country mobility by improving its quality through better transparency of **the learning outcomes** expected and achieved.
 - VET providers, mobility promoters and policy developers quite agree that this is a major added value of ECVET.
 - This points to opportunities for cooperation with the Europass Mobility, which documents the outcomes of an individual mobility experience, and its possible development.

European Credit System for Vocational Education and Training (ECVET) is a **technical framework** for the **transfer, recognition** and, where appropriate, **accumulation** of individuals' **learning outcomes** with a view **to achieving a qualification**.

Transnational mobility

Lifelong learning

R
e
c
o
g
n
i
t
i
o
n

Learning outcomes

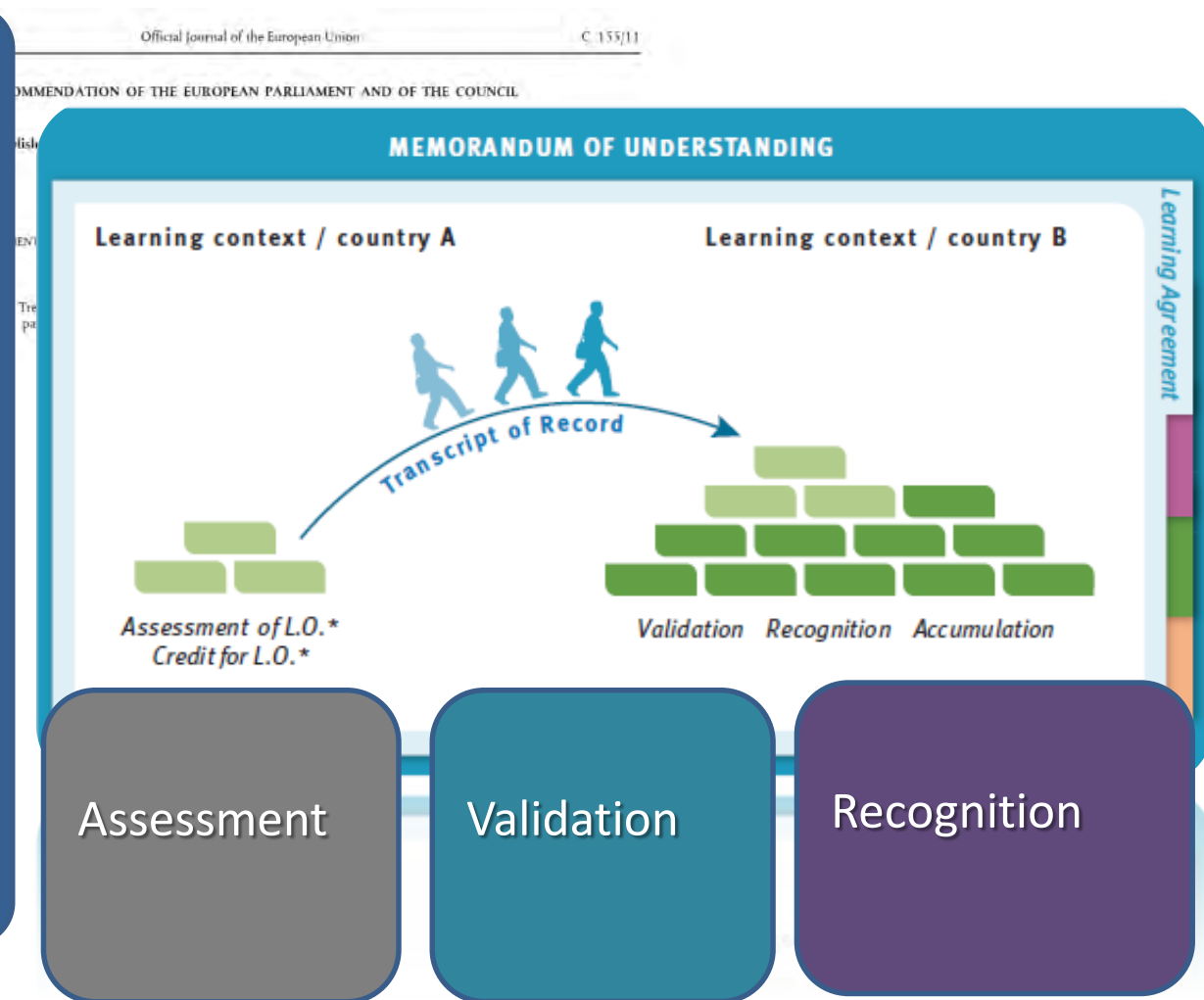

Assessment

Validation

Recognition



■ **Assessment** of learning outcomes

- establish the extent to which a learner has in fact attained particular knowledge, skills and competence

■ **Validation** of learning outcomes

- confirming that assessed learning outcomes achieved by a learner correspond to specific outcomes which may be required for a unit or a qualification

■ **Recognition** of learning outcomes

- means attesting officially achieved learning outcomes through the awarding of units or qualifications

Establish the extent to which a learner has in fact attained particular knowledge, skills and competence

- Making the decision (performance measurement)
 - what evidence, comparison gap between performance and standards, what kind of assessors (who's involved)
- Checking the decision
 - Quality Assurance, Validation
- Using the decision
 - In the ECVET perspective in a context of mutual trust, Transfer & Recognition

Performance measurement (in a context)

ECVET = Design of Units of L.O. & Trust & Transfer

- *Design (units)*

L.O. ↔ Assessment (in context)

consistency

- *Trust*

- Consistency and the quality of the Assessors

- *Transfer*

- In the ECVET context the result of the performance measurement but also Transfer

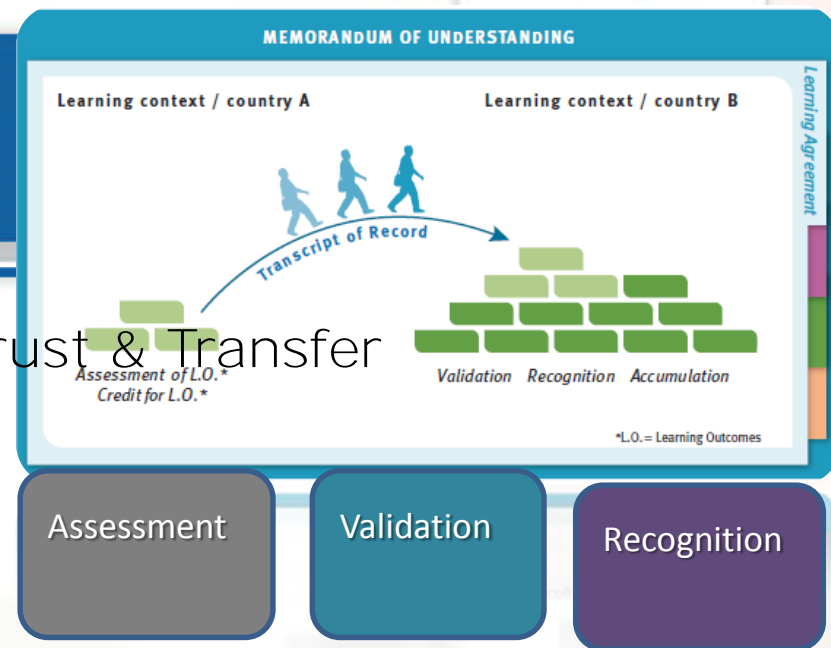

The key conditions for assessment in the perspective of T&R



- Quality of the LO / units
- Agreement partners
- Quality of the assessors
- Consistency of the assessment tools in relation with LO and context
- Transparency of assessment protocols

Q1: The key conditions



- The key conditions for assessment in the perspective of T&R in the NUCLEAR SECTOR
 - Quality of the LO / units
 - Agreement partners
 - Quality of the assessors
 - Consistency of the assessment tools in relation with LO and context
 - Transparency of assessment protocols
 -

Q2: The documentation



- How to document the achieved L.O. in the perspective of T&R in the nuclear sector



Recognised mobility

Different types of mobility



| Level | Objectives | Content | Partners | Partnership agreement | Pre-requisites |
|---|--|---|--|---|---|
| Level 1 Study visit/ Preparatory visit | EXPLORING Set up dynamics Explore conditions for possible mobility actions | Few days mobility No reciprocity in case of group mobility Professional visits/meetings Exploring-focus program | No still settled | No partnership agreement | Will to discover if pre-conditions for more sustainable mobility may exist |
| Level 2 First run of mobility | TESTING Pedagogical project, based on a job-approach Test of the partnership and of the logistic framework | Short length (at least 2 weeks) Reciprocity (or not) in case of group mobility Placement in companies (length can vary) "Classical" (soft) pedagogical program | ▶ VET centres, companies ▶ optional: institutional bodies, professional organisations | Basic partnership agreement <u>Necessary elements:</u> Group of learners or individual learners involved Mobility calendar Financial resources Logistic agreement | Capability to implement a mobility action (from the logistic point of view) Capability to suggest a relevant content Capacity to finance the action |

Different types of mobility



| Level | Objectives | Content | Partners | Partnership agreement | Pre-requisites |
|--|---|--|---|---|---|
| Level 3 Structured mobility | <p>STRUCTURING</p> <p>Strengthening linguistic skills</p> <p>In-depth pedagogical work</p> <p>Agreement between VET centres aiming at perpetuate the action</p> | <p>In-depth mobility project</p> <p>Average length (or combined short actions)</p> <p>Reciprocity (highly recommended) in case of group mobility</p> <p>Placement in companies</p> <p>In-depth pedagogical program</p> | <ul style="list-style-type: none"> ▶ VET centres, companies ▶ optional: institutional bodies, professional organisation | <p>Detailed partnership agreement</p> <p><u>Necessary elements:</u></p> <p>Group of learners or individual learners involved</p> <p>Mobility calendar</p> <p>Financial resources</p> <p>Logistic agreement</p> <p>In-depth pedagogical program</p> <p>Middle/long term agreement</p> | <p>Fulfil the level 2 pre-requisite (having experience on level 1) and:</p> <p>Capability to develop (design, and implementation) an in-depth pedagogical program</p> <p>Capability to be committed for a middle/long term</p> |

Different types of mobility



| Level | Objectives | Content | Partners | Partnership agreement | Pre-requisites |
|---|--|---|---|--|---|
| Level 4 Recognised mobility “ECVET Mobility” | <p>RECOGNITION</p> <p>Validation of unit(s) of learning outcomes acquired abroad</p> | <p>In-depth mobility project Minimum average length (or combined short actions) according to the trade concerned Reciprocity (or not) in case of group mobility In-depth pedagogical program Learning outcomes clearly defined</p> <p>Assessment and transfer defined</p> | <ul style="list-style-type: none"> ▶ VET centres, companies ▶ professional organisations, institutional bodies <p>(including competent institutions)</p> | <p>Very detailed partnership agreement</p> <p><u>Necessary elements:</u> Group of learners involved Financial resources In-depth pedagogical program including: units of LO, assessment process and transfer.</p> <p>MOU and LA</p> | <p>Fulfil the level 3 pre-requisites (having experience on level 1 and 2) and:</p> <p>Partners are all committed and legitimated to develop (design, implementation and assessment) a deep pedagogical content</p> <p>Legitimacy to assure transfer procedure</p> |

Tools for ECVET mobility

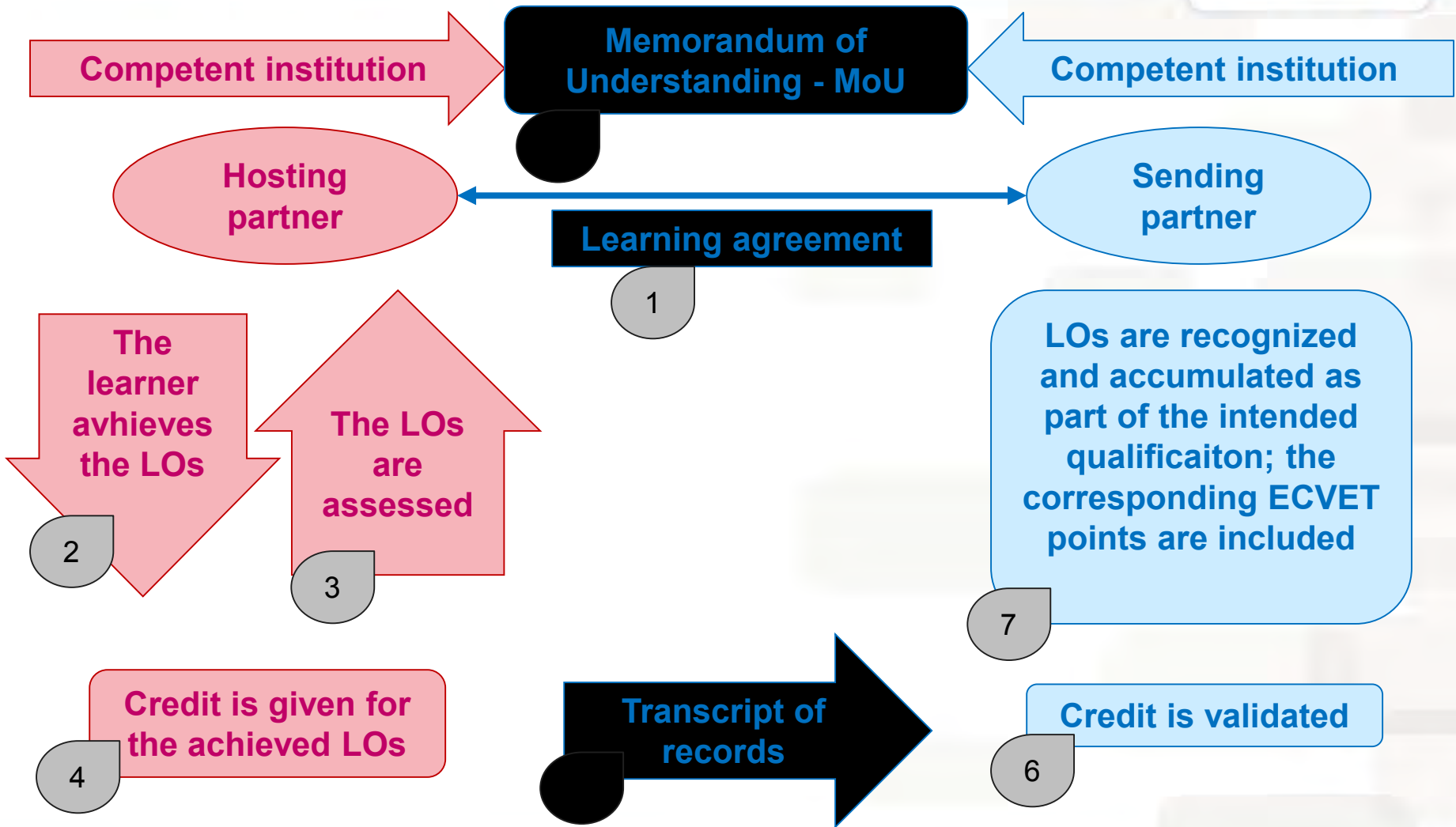



MoU / LA/ ECVET Toolbox

| Design of ECVET elements | | | Use of ECVET for accumulation and Transfer | | | |
|--|--|---|--|---|--|---|
| (F1.1.) Description of qualifications in terms of units of learning outcomes | (F2) Link between units of learning outcomes and the formal or non-formal programme | (F3) Link between assessment/ validation processes, the achievement of units of learning outcomes and award of associated ECVET points | (F4) Practical use of learning outcomes and credit for mobility | (F5.1.) Establishment of Learning agreements (F5.2.) Assessment of learning outcomes and award of corresponding credit | (F6.1.) Recording of assessed learning outcomes and credit in the personal transcript (F6.2.) Validation of learning outcomes and of corresponding credit Award of corresponding ECVET points to the learner | (F7) Recognition of learning outcomes and process for taking credit into account for the award of qualification (i.e. transfer and accumulation) |
| Transversal functions | | | | | | |
| (F8) Establishment of Memoranda of Understanding (all actors may be involved in establishment of a MoU directly or by delegation) | | | | | | |
| (F9) Provision of Information, its Documentation and Communication | | | | | | |
| (F10) Funding and governance | | | | | | |



Memorandum of Understanding

Version 2013



'File code' of the Memorandum of Understanding (optional)

(use where necessary)

1. Objectives of the Memorandum of Understanding

The Memorandum of Understanding¹ (MoU) forms the framework for cooperation between the competent institutions. It aims to establish mutual trust between the partners. In this Memorandum of Understanding partner organisations mutually accept their respective criteria and procedures for quality assurance, assessment, validation and recognition of knowledge, skills and competence for the purpose of transferring credit.

Are other objectives
agreed on? Please tick as
appropriate

No

Yes – these are: *(insert information)*



What is a Memorandum of Understanding?



- A MoU is an agreement between **competent institutions** which sets the framework for credit transfer.
- It formalises the ECVET partnership by stating the mutual acceptance of the status and procedures of competent institutions involved.
- It also establishes partnership's procedures for cooperation

What does a MoU contain?



A MoU contains statements through which the parties concerned:

- accept each other's status as competent institutions,
- accept each other's quality assurance, assessment, validation and recognition criteria and procedures as satisfactory for the purposes of credit transfer,
- agree the conditions for the operation of the partnership, such as objectives, duration and arrangements for review of the MoU,
- agree on the comparability of qualifications concerned for the purposes of credit transfer, using the reference levels established by EQF,
- identify other actors and competent institutions that may be involved in the process concerned and their functions.

Feedback

Proposed modifications
on the MoU

Strategy definition

- Creation of partnership
- Identification of competent institutions
- Elaboration of MoU
- Establishment of MUTUAL TRUST

Partnership
Quality

Assessment

Of the partnership
(according, among
others, to the
quantitative criteria)

Implementation

- LAs (potentially many)
- Assessment
- PT
- Actual mobility takes place

14 National Agencies

Translate core principles and technical specifications into
PRACTICAL PROCESSES and TOOLS

www.ecvet-toolkit.eu

Online platform of tools, examples, information and resources to support mobility practices. (templates, checklists, examples...)

Chapters on ECVET Preparation, Partnership Building and Quality Assurance.

Users can also work systematically through the steps associated with the planning, implementation and follow-up of ECVET in Geographical Mobility (Before Mobility, During Mobility and After Mobility).

NETECVET TOOL KIT



ecvet

European Credit system for
Vocational Education & Training

[home](#) | [about](#) | [user guide](#) | [sitemap](#) A A A

search...



introduction
to ecvet

Introduction to ECVET and
Geographical Mobility



ecvet
toolkit

Support for integrating ECVET into
new or existing Mobility Practice



tools, examples
& more

Tools, Examples and Further
Reading to aid successful ECVET
Integration

Key Actions Checklist: What-Who-How-Documentation

| ECVET- related issues | Building Partnerships | ECVET Before Mobility | ECVET During Mobility | ECVET After Mobility | |
|-----------------------|---|---|--|--|--|
| What? | <ul style="list-style-type: none"> Building a Partnership for ECVET mobility. | <ul style="list-style-type: none"> Formalising a partnership for ECVET mobility. | <ul style="list-style-type: none"> Defining the conditions for the mobility of each individual learner. | <ul style="list-style-type: none"> Actual training period abroad. Assessing and documenting knowledge, skills and competence acquired by the mobile learner. | <ul style="list-style-type: none"> Verifying that all formal requirements, as well as the stipulations stated in the LA, have been met; Validating and recognising learners' credit. |
| How? | <ul style="list-style-type: none"> Identifying suitable partners abroad and exchanging information. Involving competent institutions in both the sending and receiving countries (national and international partners). Mapping the roles and responsibilities of each partner in the sending and receiving countries. | <ul style="list-style-type: none"> Analysing qualification(s) and learning opportunities abroad. Identifying (units of) learning outcomes to be acquired during mobility, agreeing on the assessment procedures and how learning achievements will be documented, specifying the roles of partners involved and under which conditions credits can be transferred (validation and recognition). | <ul style="list-style-type: none"> Preparing the LA including information about: <ul style="list-style-type: none"> Unit(s)/groups of learning outcomes the learner will achieve abroad. How and when these will be assessed. How the unit(s) will be recognised. | <ul style="list-style-type: none"> Learners participate in learning activities in the hosting organisation relevant to the unit(s) they are preparing. Learners demonstrate their achievement of the required learning outcomes in an assessment process as specified in the MoU/LA Assessment organisations document the assessment results. | <ul style="list-style-type: none"> Comparing the documentation of the learning outcomes assessed by the host organisation with what has been agreed in the LA. Awarding unit(s) or qualification. Implementing practical implications agreed beforehand (for example, the learner is exempted from certain learning activities, does not have to retake exams, or acquires... Reflecting on the entire process in order to identify any necessary adaptations. For example: <ul style="list-style-type: none"> Consider whether the learning outcomes agreed for the mobility phase were appropriate. Consider whether the documentation of the assessment abroad provides sufficient evidence for recognition. |



MoU: NETINVET experience



NETINVET, an example of VET Network using ECVET principles



From European projects to NETINVET (**Net**work **IN VET** education)

- European Projects:

Cominter : Creation and implementation of a **common European qualification**
in International Trade



Recomfor : Created a **platform** for training centres and companies that see mobility as an integrated part of training pathways, to **develop common quality criteria and mutual trust.**



- NETINVET : An **independent** working Network to **ensure sustainability**

- * Partnerships
- * Units of learning outcomes identified through the shared reference
- * Learning agreements
- * A living project with a community of practices





NETINVET ECVET mobility tools



NETINVET Membership Agreement for Mobility

NETINVET NETWORK

This Membership Agreement/ MoU (Memorandum of Understanding) has been created to establish the frame for ECVET mobility actions in the European NETINVET network

Qualifications involved

Diploma de Técnico de Computación (DTC) Comercio Internacional

Personal transcript NETINVET

The Personal transcript is a record of learning achievements and part of the NETINVET Learning Agreement.

Personal details - Learner

| | |
|--------------------|--|
| Family name | |
| Name | |
| Address | |
| Postal code / City | |

Learning Agreement NETINVET

This agreement describes learning outcomes concerned by the international mobility of the learner for institutions participating in the NETINVET network. This Learning Agreement is connected to a Memorandum of Understanding (membership agreement) signed by the institutions.

Personal details - Learner

| | |
|--------------------|--|
| Family name | |
| Name | |
| Address | |
| Postal code / City | |





NETINVET

- **European network of 57 training centres and professional organisations** grouped together in an association
- **10 countries** involved
- **Mutual trust** has been established ...
- ...in order to provide learners with **mobility opportunities** during their training pathway
- **350 mobility operations** in 2013
From 2 weeks to 5 months, in work placements, exchange programs and/or study mobilities
- Enable **recognition of learning outcomes** acquired during mobility periods
- Focusing on **International Trade** and **Transport & Logistics** qualifications



NETINVET from 2011 till now

- NETINVET launched in **March 2011**
- **Cohesion was created**
- **Steering Committee** 5 times a year
- **A Scientific Committee** gives technical advises
- **National meetings:** each country organises its own meetings
- **Representatives** of NETINVET participate in meetings at **National & European level**
- **General Assembly** each year

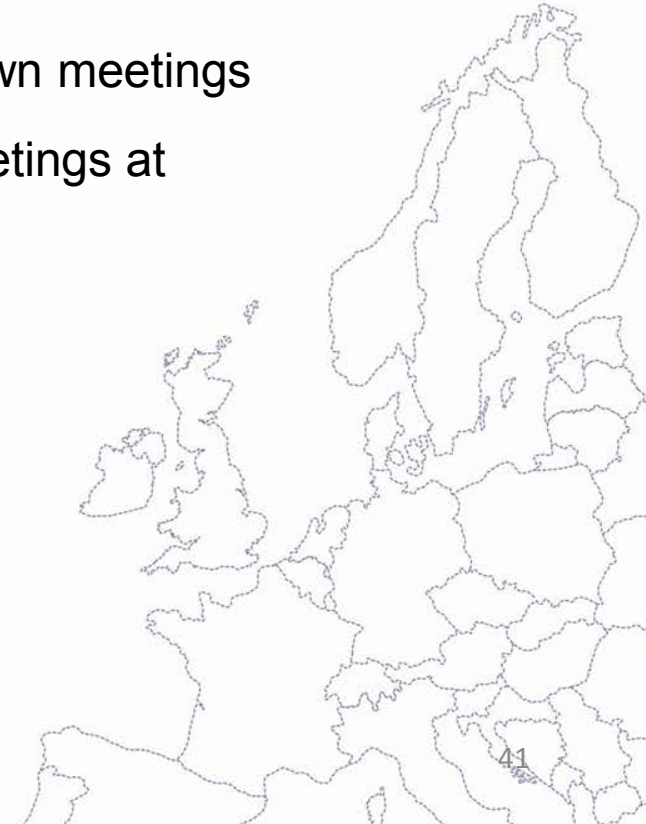



LESSONS LEARNED

- Build good relationship is **crucial (mutual trust)**
- Start **slowly** (short duration, few students) and grow step by step
- Make **good appointments in advance** with your partner
- Use the developed **tools** (website, news letters, leaflets)
- Create a **common certificate** for all NETINVET partners





DIFFICULTIES

- **Understanding the curriculum** of the partner institution: “speaking the same language”
- **Language**
- **Fitting the periods and duration requirements** (organization of studies)
- Assessment : practices are very different from a situation to another, but solutions can be found. When it comes to **validation** and even more to **recognition**, difficulties are growing...
- VET systems do not enable recognition. Need of **agreements** at high level?



Role-play

Building networks



- Build a network
- Agreement Hosting - Sending
 - Who should be involved?
 - What would be the key objective?
 - What kind of agreements are needed?
 - How to guarantee the quality?



3rd ECVET Seminar – customized for Nuclear Energy Sector

*Hotel-Nord Nuova Roma
Rome (IT) 12-14 November 2014*



ECVET TOOLKIT COSTUMIZATION for nuclear energy sector



1. Learning from existing ECVET pilot projects
2. The ECVET toolkit customization for the NES
3. Example of tools customization for NES



1. Learning from existing ECVET pilot projects



Learning from existing ECVET (non-nuclear sectors)

| Existing ECVET PP | Financing source | Projects financed |
|-------------------|--|--|
| 2008 | <ul style="list-style-type: none">call for proposal to finance international partnerships under the lifelong learning action programme | <ul style="list-style-type: none">11 projects selected (aircraft industry; automotiv, etc.) |
| 2010 | <ul style="list-style-type: none">new call for proposal to finance a new generation of pilot projects under the lifelong learning programme | <ul style="list-style-type: none">8 projects selected (health care, metal industry, etc) |

1. Learning from existing ECVET pilot projects



How could be capitalized the experience of ECVET PP?

Using the tool box delivered by the existing ECVET PP

<http://www.ecvet-projects.eu/ToolBox/Default.aspx>

- contains outcomes of the ECVET PP:
 - a) key elements of a PP
 - b) methodologies for designing of LU
 - c) models for MoU and LA
 - d) processes for assessment, validation and recognition in the context of mobility



1. Learning from existing ECVET pilot projects



Example of using the tools developed by existing ECVET PP:

- Key elements of a PP:
 - a1) Partnership/ Project consortium
 - a2) Project structure
 - a3) PP-test ECVET in the context of mobility of individual learners

NUClear-VET pilot project/NUC-VET PP

| | |
|---|---|
| a) Partnership/ The project consortium | The ideal structure of NATIONAL NUC-VET network: |
| | ✓ Industry: NPP, RadWaste facility, other type of nuclear facilities |
| | ✓ National Administration (competent for qualification accreditation) |
| | ✓ Regulatory body – TSO |
| | ✓ E&T providers |

1. Learning from existing ECVET pilot projects

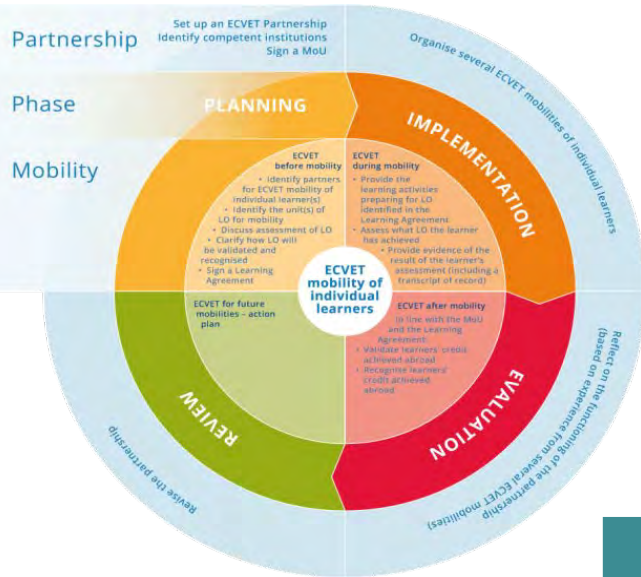

Example of using the tools developed by existing ECVET PP:

- **Key elements of a PP:**
 - a1) Partnership/ Project consortium
 - a2) Project structure
 - a3) PP-test ECVET in the context of Mobility of individual learners

| NUC-VET pilot project | |
|-------------------------------------|---|
| a2) The NUC-VET PP structure | set out in four phases; lasts 3 years |
| | Preliminary phase (1): selecting one or more professions to be “nuclearized” |
| | Preparation phase (2): agreeing on the specific learning outcomes to be gained during the learning period abroad |
| | Implementation phase (3): learning period abroad |
| | Final phase (4): assessment and recognition of the learning outcomes achieved abroad |

2. Example of ECVET tools customization for NES

2.1 Preconditions for PP setting up



- **ECVET concepts-clearly understood by involved actors** (learners, teachers and trainers in home & host institutions; competent institutions →for validating and recognising LO achieved during mobility)
- **Defining LOs achieved during mobility** (learners' existing knowledge, skills and competence; the duration of the planned mobility)
- **Initial requirements for LO assessment abroad** (learners' foreign language skills)
- **LO recognition** when the learner returns to the home institution

2. Example of tools customization for NES

2.2 ECVET features of a qualification



The ECVET structure of a qualification—three dimensions

Question: where would be found the Learning Units?

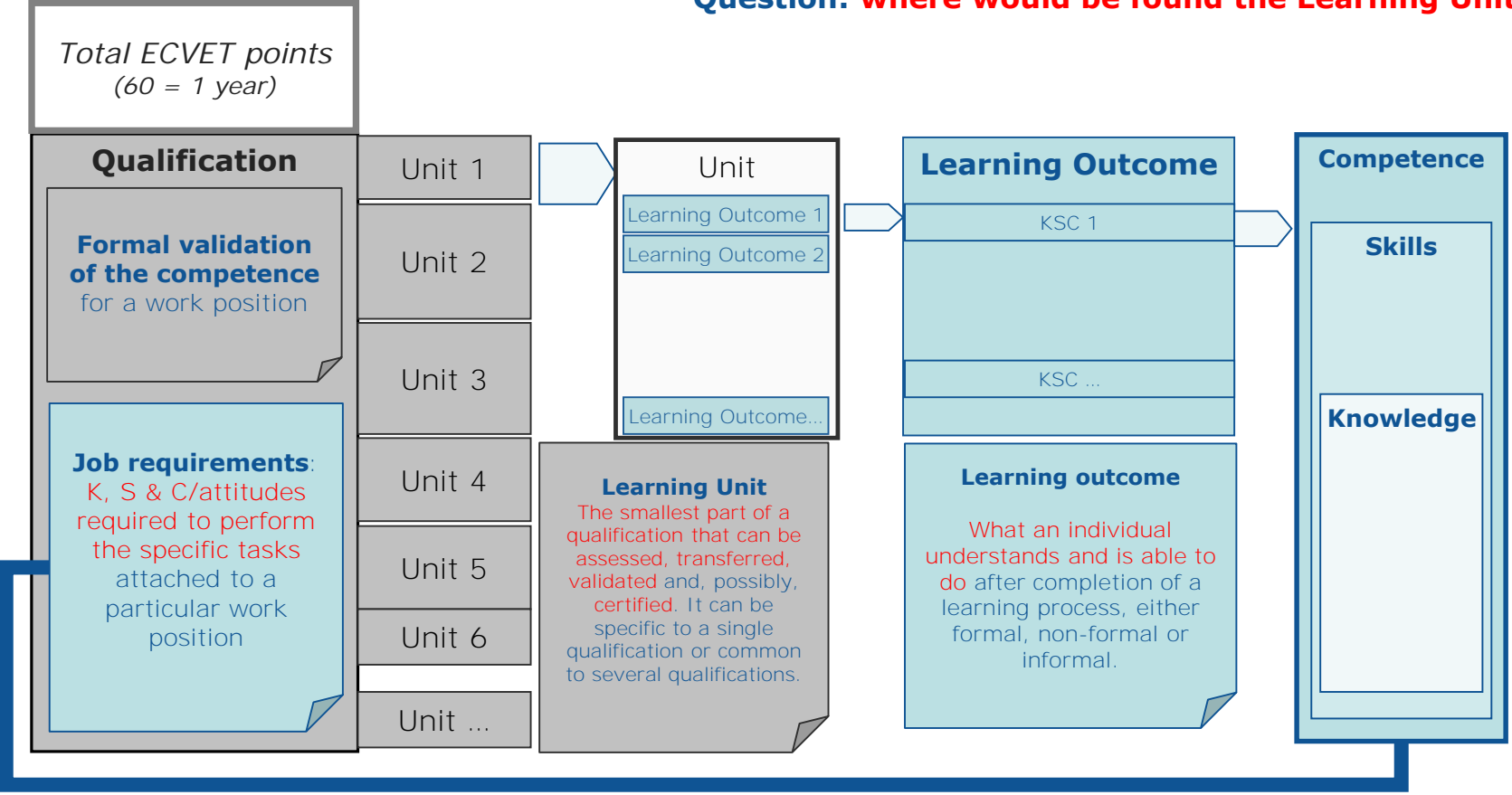

Source: Definitions from: <http://europass.cedefop.europa.eu/en/education-and-training-glossary>

2. Examples of tools customization for NES



2.3 Case study

| NUC-VET pilot project/Case study | |
|---|---|
| Preliminary phase (1): | Case study: TPP operator → profession to be "nuclearized" → NPP-CRO |
| selecting one or more professions to be "nuclearized" | Methodological aspects → "nuclearization" process? "nuclearization" = upgrading of a non-nuclear qualification to a nuclear qualification |



2. Example of tools customization for NES



2.3 Case study

| Ref. | Job Title | Occupational Category |
|---|---|---------------------------|
| 2.2.02 | Senior Reactor Operator | Professional / Technician |
| Phase / Area | Alternate job title(s) – specialisations | Functional Category |
| NPP O | Head of Reactor Unit Control Room Operator | Executive |
| Control Room | | |
| Role / Functions | | |
| Responsible for all aspects of safe operation of reactor facility. | | |
| <ul style="list-style-type: none"> Ensures and controls the safe and trouble-free operation of reactor facility according to the requirements of technical specifications: (radiation situation, chemical regime, technological limits and conditions). Provides overall supervision of all activities in the operation of the reactor installation and its auxiliary systems and directly manipulate the controls of the equipment and systems. Monitors and controls the core, the reactivity and the systems, which can influence the reactivity. Ensures and controls the strict adherence to the requirements of nuclear safety and radiation protection in all activities related to the operation of the reactor installation. Reports to the Unit shift supervisor the operational condition of reactor facility or/and incidents occurred. Coordination of maintenance and testing activities and for a start-up of the equipment after maintenance Monitors parameters of assigned equipment during operations and ensure the response to system or unit abnormalities, diagnoses the cause, and recommends or applies corrective action and reports incidents. Responsible for recording and continuous update of operating registers. During the outage for refuelling, coordinates and monitors activities in the controlled area. In case of abnormal or emergency situation strictly adheres the instructions of the Unit Shift Supervisor in accordance with the Emergency Operating Procedures and the internal emergency plan. Interfacing with other departments of the organization in framework of his duties. Responsible for implementation of operational procedures such as those controlling start-up and shut-down activities, including periodic testing of relevant equipment. | | |

- Case study:
 - 2.3.1) design the Learning Units for CRO qualification
 - 2.3.2) design the Learning Outcomes for CRO qualification
 - 2.3.3) design the Training Programme for CRO

- Suggested methodology:
 - INPUT data: CRO JD_2.2.02 (Input 1)
 - design LU for the CRO qualification answering questions:
 - a) choosing small or large units?
 - b) are the units in line with the roles/functions of the job?

→ Procedure: working in groups of 3-4/
15-20 min



Solution:

Senior Reactor Operator/CRO

Formal validation of the competence for **Senior Reactor Operator/CRO** position

Job requirements: the KSC required to perform the CRO's functions/roles (K,S, C/A defined in the JD 2.02.02)

Case study 2.3.1: The shift from KB-QS to CB-QS for CRO qualification:

Three dimensions of a qualification in the **CB-QS**:

- d1) formal validation of the CRO competence;
- d2) job requirements- in terms of KSC/A; detailed in the JD-CRO 2.2.02;

2. Examples of tools customization for NES



2.3 Case study

→ **Solution:** design the Learning Units for CRO qualification

Case study 2.3.1: The shift from KB-QS to CB-QS for CRO qualification:

Three dimensions of a qualification in the **CB-QS**:

- d1) formal validation of the CRO competence;
- d2) job requirements- in terms of KSC/A; detailed in the JD-CRO 2.2.02;
- d3) CRO qualification structured in **Learning Units**

- **linked with CRO roles from JD**
- **large Units (less time for assessing and certifying)?**
- **small Units (more time for assessing and certifying)?**
- **6 Learning Units (depends on designer experience)**

| | |
|---|---|
| <p>Senior Reactor Operator/CRO</p> <p>Formal validation of the competence for Senior Reactor Operator/CRO position</p> <p>Job requirements: the KSC required to perform the CRO's functions/roles (K,S, C/A defined in the JD 2.02.02; NucT8 and NucT9)</p> | Unit 6= Management of abnormal/emergency situation |
| | Unit 5=Training programmes for control room crew |
| | Unit 4= Team and technical supervision |
| | Unit 3= Interfacing with other departments |
| | Unit 2=Maintenance and testing activities |
| | Unit 1= Operation of reactor facility |

Source: 2nd ECVET Seminar

2. Example of tools customization for NES



2.3 Case study

| | |
|---|--|
| <p>Senior Reactor Operator/CRO</p> <p>Formal validation of the competence for Senior Reactor Operator/CRO position</p> <p>Job requirements: the KSC required to perform the CRO's functions/roles (K,S, C/A defined in the JD 2.02.02; NucT8 and NucT9)</p> | <p>Unit 6= Management of abnormal/emergency situation</p> <p>6.1 Nuclear incidents assessment/5 6.2 Emergency response management/5</p> |
| | <p>Unit 5=Training programmes for control room crew</p> <p>5.1 Input for licensing flow for CRO /6 5.2 Input for CRO refreshments-at each 6 month/6</p> |
| | <p>Unit 4= Team and technical supervision</p> <p>4.1 Technical supervision/6 4.2 Team supervision/5</p> |
| | <p>Unit 3= Interfacing with other departments</p> <p>3.1 Interfacing with maintenance department/4 3.2 Interfacing with instrumentation and control /4 3.3 Interfacing with other departments/4</p> |
| | <p>Unit2=Maintenance and testing activities</p> <p>2.1 Nuclear equipment maintenance/5 2.2 NPP systems and components/5</p> |
| | <p>Unit 1= Operation of reactor facility</p> <p>1.1 Nuclear operation and national lows/6 1.2 Radiation protection and emergency response/5 1.3 Chemical regimes of fluids /4</p> |

Case study 2.3.2: Designing LO for CRO qualification

- LO definition:
- 2.1) KSC/A linked with a specific competence;
 - 2.2) job requirements- in terms of KSC/A; detailed in the JD-CRO 2.2.02;

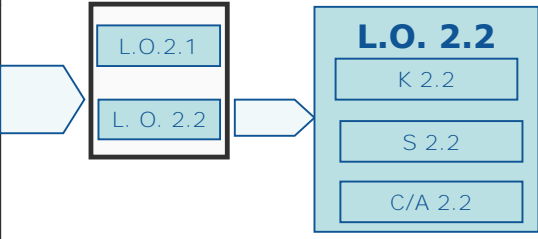

Source: 2nd ECVET Seminar

2. Examples of tools customization for NES



2.3 Case study

| | | | |
|--|---|--|------------|
| Unit 2 | Maintenance and testing activities (ECVET approach-the name of Learning Unit 2 is one of the functions/roles) | | EQF |
| LO 2.2 | LO 2.2= NPP systems and components | | 6 |
| | KSC/A | JD_Senior Reactor Operator/CRO_2.02.02 | |
| NPP systems and components | K 2.2 | <ul style="list-style-type: none"> Recall and outline the chain of energy transformations in NPP/EQF 6 Describe the main systems of NPP (1st loop/ Primary Heat Transport System, 2nd loop/ power circuit, Nuclear security system) Describe the key components of NPP (Nuclear Reactor; Steam generators; pumps; heat exchangers; etc.) /EQF 5 Identify construction materials for nuclear equipment/ EQF 4 | 6 |
| | S 2.2 | <ul style="list-style-type: none"> Prepare the nuclear equipment for maintenance and tests/EQF 6 Using and interpreting engineering data and documentation/ EQF 5 Providing input for the draft of requirements specifications/ EQF 4 | 5 |
| | C/A 2.2 | <ul style="list-style-type: none"> Team Working/ EQF 4 Capacity to act upon problems/ EQF 5 Demonstrate safety culture/ EQF 5 | 5 |
| Assessment procedures: K) a written test (multiple-choice or other forms) to assess knowledge; S) a practical test (simulator test for NPP operator) to assess the competence as a whole, including skills; C/A) a set of 'case histories' related to the assessed competence/attitude | | | |

Case study 2.3.2: Designing LO for CRO qualif.

- LO definition:
- 2.1) KSC/A linked with a competence;
 - 2.2) job requirements- in terms of KSC/A; detailed in the JD-CRO 2.2.02;
 - 2.3) defining K2.2; S2.2&A2.2
 - are K,S and C/A defined using the proper action verbs?
 - could be the LO assessed and evaluated?

2. Examples of tools customization for NES



2.3 Case study

Case study 2.3.3: Designing training programme for CRO qualification

| | | |
|--|---|--|
| <p>Senior Reactor Operator/CRO</p> <p>Formal validation of the competence for Senior Reactor Operator/CRO position</p> <p>Job requirements: the KSC required to perform the CRO's functions/roles (K,S, C/A defined in the JD 2.02.02)</p> | <p>Unit 6= Management of abnormal/emergency situation</p> <p>6.1 Nuclear incidents assessment /5</p> <p>6.2 Emergency response management /5</p> | <p>CRO/ EQF 5 Licensing flow ≈2 years</p> |
| | <p>Unit 5=Support training programmes for control room crew</p> <p>5.1 Input for licensing flow for CRO /6</p> <p>5.2 Input for CRO refreshments-at each 6 month /6</p> | <p>Working under supervision =6 month</p> <p>LU5, LU6 recognition&validation</p> <p>CRO licensing by NPP management</p> |
| | <p>Unit 4= Team and technical supervision</p> <p>4.1 Technical supervision /6</p> <p>4.2 Team supervision /5</p> | <p>Practical training on simulator =6 month</p> <p>LU3, LU4 recognition&validation</p> <p>Review by regulatory body</p> |
| | <p>Unit 3= Interfacing with other departments</p> <p>3.1 Interfacing with maintenance department /4</p> <p>3.2 Interfacing with instrumentation and control /4</p> <p>3.3 Interfacing with other departments/4</p> | <p>Nuclearization = 4 month</p> <p>LU1, LU2</p> |
| | <p>Unit 2=Maintenance and testing activities</p> <p>2.1 Nuclear equipment maintenance /5</p> <p>2.2 NPP systems and components /5</p> | |
| | <p>Unit 1= Operation of reactor facility</p> <p>1.1 Nuclear operation and national laws /6</p> <p>1.2 Radiation protection and emergency response /5</p> <p>1.3 Chemical regimes of fluids /4</p> | |





ECVET NUCLEAR PILOT PROJECT

Concept, processes, outcomes





- Funding schemes
- Overall concept and connection to ongoing projects
- Scope with regard to European E&T initiatives
- Actors to be included
- Targeted learners / type of learning
- Processes and outcomes



- Funding schemes

Sector skill alliances

Euratom Fission E&T calls

NUGENIA

Erasmus+, Marie Curie

Technology platforms. Watch the calls.

Sector Skills Alliances: Applying might be possible without an existing sector skill council.

Cluster concept

- Stand-alone or “embedded”; or something else

Established platforms with work packages aimed to the implementation of ECVET

Pros and cons. Dimension factor

UK as example the national initiative

Necessary a first contact with ENSREG to check their interest

- Bilateral vs multinational project



- Scope: integration of different European initiatives
EQAVET + EQF + Validation of Non- Informal Learning +
ESCOS + ECTS + Europass



- Actors / Partners

Industry

1. Nuclear power plant
2. Utility
3. Waste management

E&T providers

1. Universities
2. Eng. & Consultancies
3. Research institutes

Regulatory bodies

National Admin. E&T

Industry association

Professional association

Platforms / projects



- Actors / partners



• Targeted learner

- Student of V&T
- Student of HE
- Just graduated BS/MD
- Nuclear professional (upgrade/update)
- Professional to be nuclearized
- Trainer / Training designer

• Types of learning

- Vocational (secondary, postsec.)
- Training complementary to HE
- Apprenticeship/hands-on learning
- Formal classroom-based
- Non-formal and informal: assessment and validation
- Continuous training / lifelong learning

Nuclearization. Continuous professional development as the main targets.

Industry needs can vary from country to country.

ENETRAP is implementing "training of the trainer" strategy.

Modern training methods and use of technology might help to attract technicians

Use of online learning methods, flexible pathways to help attractiveness of nuclearization.

Modernization of learning.

- Targeted learners / specific field

Areas within the nuclear energy field where the need to preserve and build up competence is more impending

- Radiation protection
- NPP Design and new build
- Safeguards
- NPP Operation
- Dismantling & decommissioning
- Waste management
- Training
- Management
- Other...

Dismantling and Decommissioning

Radiation Protection, NPP Operation

Decommissioning might be the best. It is being undertaken in many countries and definitions are being devised. It-s also an area more suitable for mobility.

Other : GENIV

ECVET NUCLEAR PILOT PROJECT

Processes and outcomes

• Processes and outcomes

- Identify jobs, competences and qualifications
- Design of qualifications
- Mobility and transfer
- Assessment and validation

- Nuclear qualifications catalogue
- Methodology for qualification design and LO formulation
- Protocols and tools for mobility
- Procedures for validation of non-formal learning
- Proposals for comparability and permeability with ECTS
- Developing IT tools
-

IT tools already exists (examples to be circulated)
Companies are using IT tools; compatibility is difficult.
Almost every nuclear operator has IT tools for management of jobs and training, but they'd not share it.

Identification of jobs suitable for reference profiles

EQF8 not only for Research, a pilot project should cover at least 6-7 EQF. Important to see how the system can be adapted to those levels. Lower levels are already tested in other sectors.

MD sometimes doesn't provide skills for specific tasks.

Nuclearization as main goal. The project should undertake higher levels and keep a direct link with diploma achieved.

The focus should be set in continuous learning, lifelong learning and professional development

Initial qualification is not relevant

There is a need to have ways for recognition in mobility cases.

Need communicate among different projects and industry.



- *From industry point of view, mobility is often not desirable. Sharing systems can make it easier. Industry does not have the same prospective on mobility as individuals or universities.*
- *SWOT analysis on ECVET? It might be done at sector level, not for the ECVET initiative as a whole.*
- *Euratom research program is questioned;*

3rd ECVET Seminar – customized for Nuclear Energy Sector



Sketches of NUC-VET pilot projects

Setting up a NUC-VET pilot project

Sketches of NUC-VET pilot projects

National NUC-VET networks

- **Project consortium:**
 - a) applicant/project leader: the learner sender or the learner host
 - b) learner sender profile: **Industry- NPP, RadWaste facility, other type of nuclear facilities**
 - c) learner host profile: **Industry, E&T provider**





Setting up a NUC-VET pilot project

Sketches of NUC-VET pilot projects

European NUC-VET networks

- Project consortium/European NUC-VET networks involved
- Professions to be "nuclearized"/upgraded
- Learning outcomes to be gained abroad
- Possible methodological aspects

European NUC-VET networks

Petrus III

B. BAZARGAN
SABET

ENETRAP III

Th. BERKVENS

ENEN

P. PORRAS
DIEGUES

Setting up a NUC-VET pilot project

Sketches of NUC-VET pilot projects

- Project consortium/national NUC-VET networks involved
- Professions to be "nuclearized"/upgraded
- Learning outcomes to be gained abroad
- Possible methodological aspects



National NUC-VET networks

National NUC-VET networks

| | |
|------------|------------------------|
| Austria | A. HEFNER |
| Bulgaria | L. PYRONKOV; M. ILIEVA |
| Czech Rep. | R. REZAC |
| France | P. LIVOLSI |
| Germany | M. KUGLSTATTER |
| Italy | G. CONSTANTINI |
| Romania | O. COMSA; G.L. PAVEL |
| Spain | J. IGLESIAS MORAM |

ECVET for the Nuclear Energy Sector

ENETRAP III NUC-VET pilot project

Thomas Berkvens
Project collaborator
SCK•CEN Academy for Nuclear Science and Technology
tberkven@sckcen.be

Third ECVET seminar for the Nuclear Energy Sector
Rome, 12-14 November 2014



| Participant Organisation Name | Profile | Country |
|--------------------------------------|-------------------------|-----------------|
| SCK•CEN | Research / E&T | Belgium |
| PHE | Governmental | United Kingdom |
| BfS | Governmental | Germany |
| CEA-INSTN | Research / E&T | France |
| KIT | Research / E&T | Germany |
| CIEMAT | Research / E&T | Spain |
| NRG | Research | The Netherlands |
| EFOMP | Professional federation | United Kingdom |
| EUTERP | E&T / foundation | The Netherlands |
| IST-ID | Higher education | Portugal |
| BME | Higher education | Hungary |
| PGE SA | Industry | Poland |
| Université de Lorraine (UL) | Higher education | France |



European approach “driving forces of ENETRAP(s)”

- Council Directive 96/29/EURATOM, laying down **Basic Safety Standards** for the protection of the health of workers and the general public against the dangers arising from ionizing radiation
- Communication 98/C 133/03, concerning its implementation
 - **E&T programmes** developed in EU Member States
 - **Wide variety in terminology** (QE, RPE, RPO, personnes compétentes, ...)
 - **Wide variety of national approaches** for E&T programs and for the recognition of “qualified experts” in EU member states

Approach to harmonization by ENETRAP and ENETRAP II

- New Euratom BSS Council Directive 2013/59/EURATOM
 - **RPE, RPO, MPE**
 - **Framework of ENETRAP III**



- ENETRAP III adds **new and innovative topics to existing E&T approaches in RP**. It will further develop the European reference training scheme with additional specialized modules for **Radiation Protection Experts** working in medical, geological disposal and NPP. It will **implement the ECVET principles** and will establish targeted assistance from regulators that will play a crucial role in the **endorsement of the proposed courses and learning objectives**.
- ENETRAP III will also **introduce a train-the-trainer** strategy.
- All organised pilot sessions will be open to young and more experienced students and professionals. In this way, ENETRAP III aims to contribute to increasing the attractiveness of nuclear careers and to lifelong learning activities.



- ENETRAP III will also **propose guidance for implementing E&T for Radiation Protection Experts and Officers**, hereby providing extremely important assistance to all Member States who are expected to transpose the new Euratom BSS (Council Directive 2013/59/EURATOM) requirements into their national legislations.
- Moreover, ENETRAP III will **demonstrate the practical feasibility** of earlier developed concepts for **mutual recognition** and thus provide leading examples in Europe demonstrating effective borderless mobility.
- For all these activities ENETRAP III will **strongly connect with all stakeholders**, i.e. end-users, E&T providers, legal authorities, and to other relevant international organisations, groups and networks dealing with E&T in radiation protection.

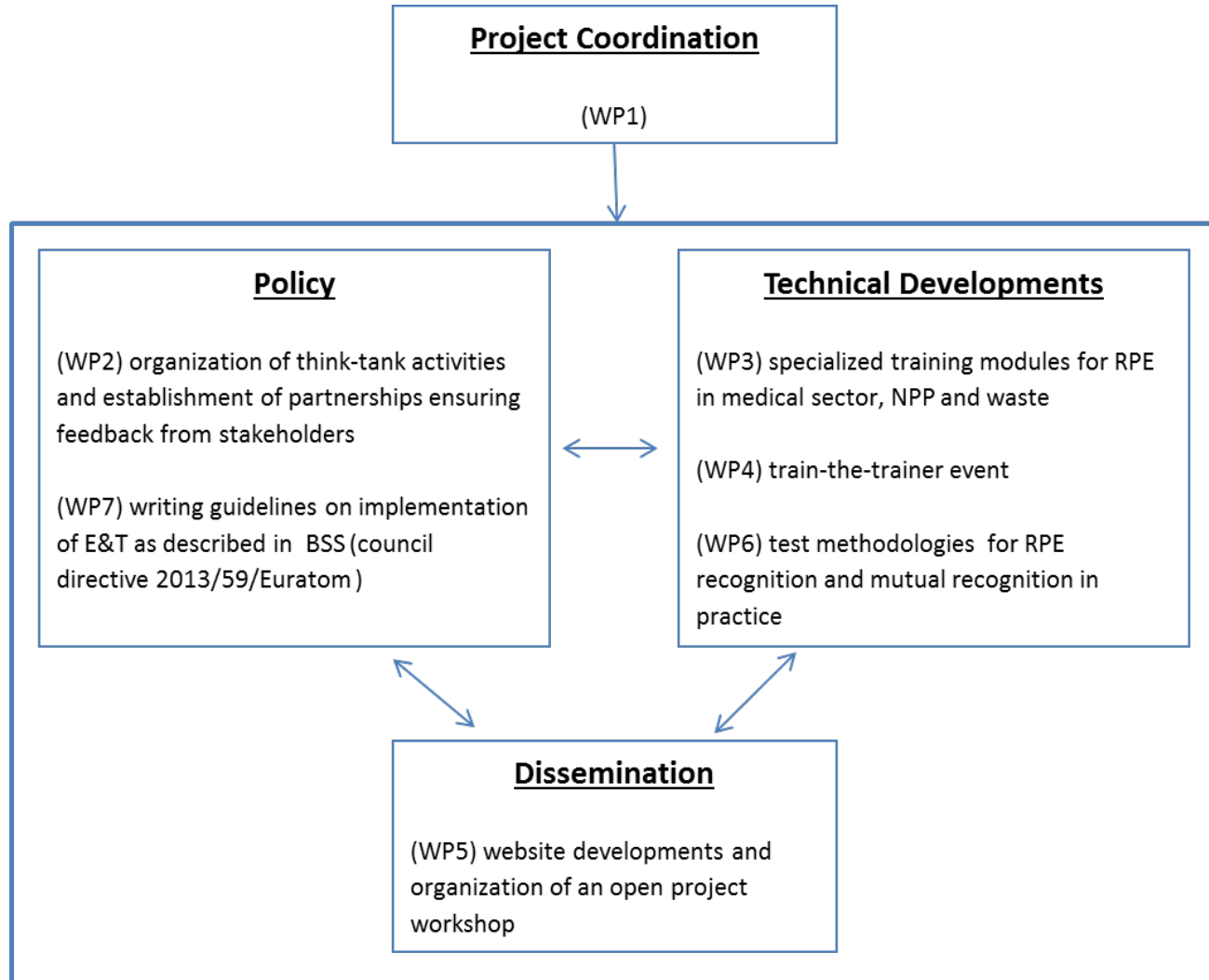



■ RPE - focus

- An individual or, if provided for in the national legislation, a group of individuals having the knowledge, training and experience needed to give radiation protection advice in order to ensure the effective protection of individuals, and whose competence in this respect is recognised by the competent authority

■ RPO

- An individual who is technically competent in radiation protection matters relevant for a given type of practice to supervise or perform the implementation of the radiation protection arrangements

■ MPE (to be developed by EFOMP)



Reference training scheme RPE

Optional modules

8. NORM (30h)

NORM activities - Dose of workers - Dose of population - Protective measure - corrective actions

▲ 4

ALARA

Additional module could be organized with European ALARA Network - EAN

DOSIMETRY

Additional module could be organized with European Radiation Dosimetry Group - EURADOS

Additional Module

Accidental situations – RP simulation codes and tools – Emergency Response - Communication – Train the trainers... or during refresher courses

Add-on modules

4. NPP Research (30h)

Reactor types – Fusion - Fuel Cycle - Dose Monitoring - Regulatory control - Safety Culture - Accidental situations - Criticality

▲ 4

5. Waste, Dec. (30h)

Waste Management - Decommissioning - Ventilation, filtration - Transport

▲ 4

6. Non nuclear (30h)

Irradiators/generators - Accelerators/Gauges - Industrial Radiography - Unsealed sources - Accidental situations

▲ 4

7. Medical (30h)

Equipment - Occupational Radiation Protection - Classification of areas - Accidental situations

▲ 4

Common Basis @

1. Basics (35h)

Radioactivity - Interactions - Quantities and Units - Basic biology & Bio. Effects - Physical principles of detection - Applications of Ionis. Radiation (overview)

4

2. Foundation (50h)

RP and External Dosi. - Prot. against external - Prot. against internal - Dose monitoring - Regulatory Framework - Natural sources - Public / Environmental - Ethical considerations

▲ 6

3. Occupational (30h)

Transport - Design issues - Accidents & Emergency issues - Safety Culture – ALARA - Decommissioning Principles – Waste Management principles

4

(h) indicative duration
▲ OJT
@ b-learning possibility

4 } ECVET unit



Learning Outcomes - examples

| 1. Basics | (35h) |
|---|-------|
| Radioactivity - Interactions - Quantities and Units - Basic biology & Bio. Effects - Physical principles of detection - Applications of Ionis. Radiation (overview) | 4 |

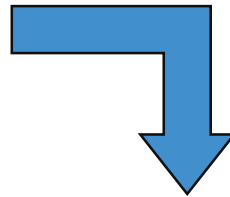

500+ LO's have been developed

| List of RPE competences |
|---|
| Understand the phenomenon of radioactivity |
| Understand the interaction of ionising radiation with matter |
| Apply the dosimetric concepts |
| Apply the different operational quantities used for dosimetry |
| Know the biological effects of ionising radiations |
| Analyse/understand an epidemiological study |
| Use different detection devices |
| Describe the main uses of radiation in various fields |

| List of RPE sub competences |
|--|
| Define nuclei property |
| Explain principal concept of basics nuclear model |
| Define quantities characterising nuclei |
| Explain the main type of interactions with matter in function of nature and energy of radiations |
| Compare with the neutron interactions |
| Differentiate the efficiency of different shielding for different radiations |
| Assess and interpret external dosimetry |
| Evaluate internal and/or superficial dosimetry |
| Describe dosimetric quantities |
| Classify the different biological effects (deterministic, stochastic and hereditary effects) |
| Assess of the risks linked to doses |



- Mutual recognition of **national qualification schemes**
 - For qualified professionals
 - Based on the reference training scheme for RPE
 - Exception of national legislation and language 'units'

- Transfer and recognition of **achieved learning outcomes**
 - For professionals 'in training' towards a qualification
 - Learning outcomes achieved in the home country or abroad
 - Based on the reference training scheme for RPE

National qualification 1

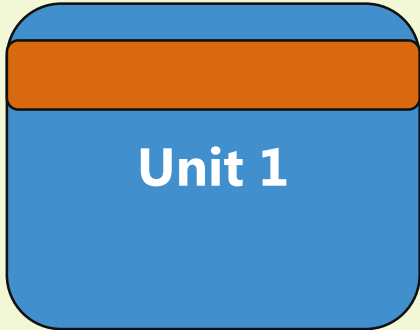

Reference qualification

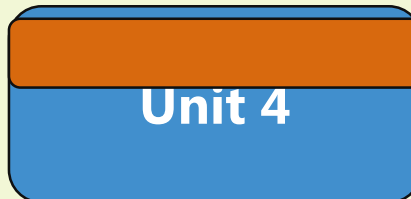
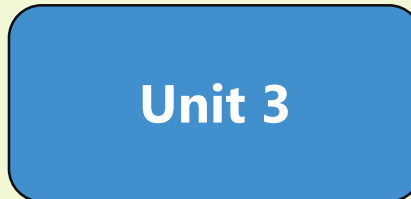
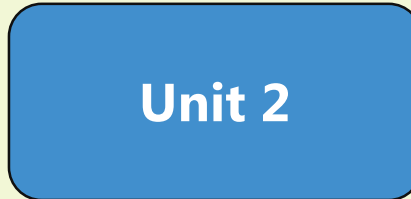
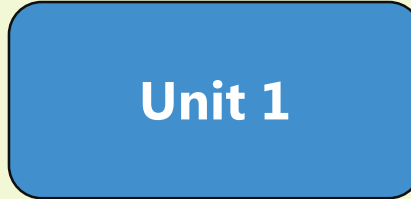

National qualification 2

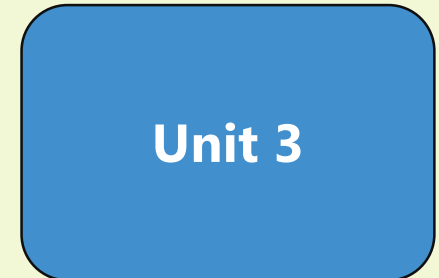
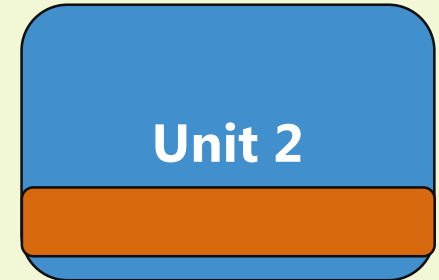
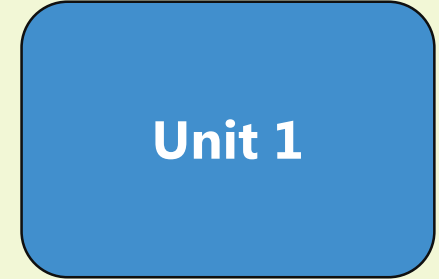



Pilot Impelementation of ECVET in the frame of CORONA Academy

Marinela Ilieva >>

Senior Expert, Nuclear Engineering Department

3-rd ECVET seminar for the nuclear sector

Rome, 12-14 November 2014



*Reliability, Safety and Management
Engineering and Software Development Services*



CORONA project goals

General goal of the project is to provide a special purpose structure for training and qualification of personnel for serving VVER technology as one of nuclear power options used in EU.

This structure is based on three general pillars:

- 1) Training schemes for VVER nuclear professionals; for non-nuclear specialists and contractors, involved in nuclear sector; and for students;
- 2) VVER related knowledge management system, which will accumulate information regarding design data, operational experience, training, etc.; and
- 3) Specialized regional training center for supporting VVER customers with theoretical and practical training sessions, training materials and general and special assignment training tools and facilities.



Target groups

| CORONA PROJECT TARGET GROUPS | |
|---|---|
| GROUP A | NUCLEAR PROFESSIONALS AND RESEARCHERS |
| Sub-Group A1 | BASIC TRAINING SCHEME |
| Sub-Group A2 | ADVANCED TRAINING SCHEME |
| GROUP B | NON-NUCLEAR PROFESSIONALS AND SUBCONTRACTORS |
| Sub-Group B1 | BASIC TRAINING FOR CONTRACTORS |
| Sub-Group B2 | BASIC TRAINING FOR NON-NUCLEAR PROFESSIONALS |
| GROUP C | STUDENTS STUDYING NUCLEAR DISCIPLINES |
| Sub-Group C1 | BASIC TRAINING FOR POWER AND NON-POWER NUCLEAR STUDENTS |
| Sub-Group C2 | BASIC TRAINING FOR NON-NUCLEAR STUDENTS |
| GROUP D SAFETY CULTURE AND SOFT SKILLS | IN FACT THIS IS NOT SEPARATE TARGET GROUP! GROUP D INCLUDES MEMBERSHIP OF ALL OTHER GROUPS BUT IN DIFFERENT CLASSIFICATION BECAUSE OF SPECIFIC REQUIREMENTS TO COMPETENCIES. |



Evaluation of the viability of the idea for Regional Center of Competence

The following pilot courses were conducted as follows:

- Two pilot courses were conducted for group A: Specialized training on specific VVER technology aspects for nuclear professionals and researchers:
 - Pilot Course titled “Certain Aspects of NPP Lifetime Management” organized by the Intellectual Technologies Slavutich, Ukraine and carried out at Kozloduy NPP;
 - Pilot course titled “Training on experimental physics at LR-0 reactor” organized and carried out at CV Rez, Czech Republic.
- Pilot course for Group B non-nuclear professionals organized by the INRNE and carried out at INRNE and Kozloduy NPP
- Pilot course for Group C students studying nuclear disciplines titled “Safety aspects of VVER-technologies” organized and carried out in the MEPHI, Russia.
- Pilot course for managers and nuclear professionals titled “Training on safety culture, soft skills and human performance tools” organized by the TECNATOM, Spain and carried out in Loviisa, Finland.



KM Portal

Information

- i. News
- ii. VVER Reactor Information

Education

- i. Training resources from Project CORONA
- ii. Links to external training and education providers
- iii. Knowledge Resources

Collaboration

- i. Discussion Forums
- ii. Blogs
- iii. Social networks

About Project CORONA

- i. Overview
- ii. Work Packages
- iii. Project Participants
- iv. Achieved Results
- v. Reference Documents
- vi. Contact Us



CORONA Academy

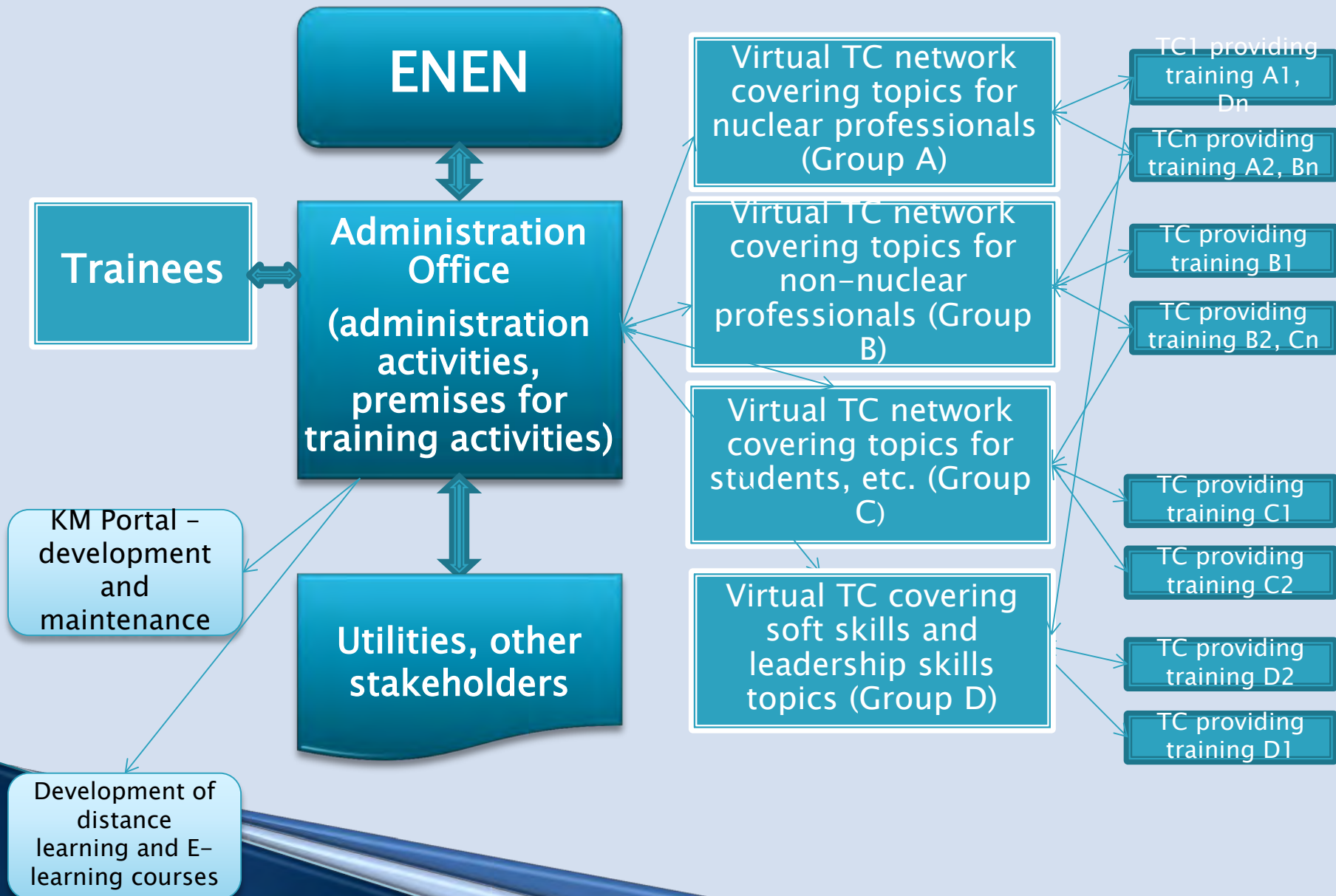



The CORONA project partners

| Participant No * | Participant organisation name | Country |
|-------------------------|---|-----------------------|
| 1 (Coordinator) | Kozloduy NPP PLC | Bulgaria |
| 2 | Institute of Nuclear Research and Nuclear Energy – Bulgarian Academy of Sciences | Bulgaria |
| 3 | Engineering Support and Intellectual Solutions (ESIS GmbH) | Germany |
| 4 | TECNATOM S.A. | Spain |
| 5 | Centrum Vyzkumu REZ S.R.O. | Czech Republic |
| 6 | National Research Nuclear University MEPhI | Russian Federation |
| 7 | Risk Engineering Ltd. | Bulgaria |
| 8 | Budapesti Muszaki es Gazdasagtudomanyi Egyetem | Hungary |
| 9 | Reseau Europeen pour l'Enseignement des Sciences Nucleaires (ENEN Association) | France |



The CORONA project organisation

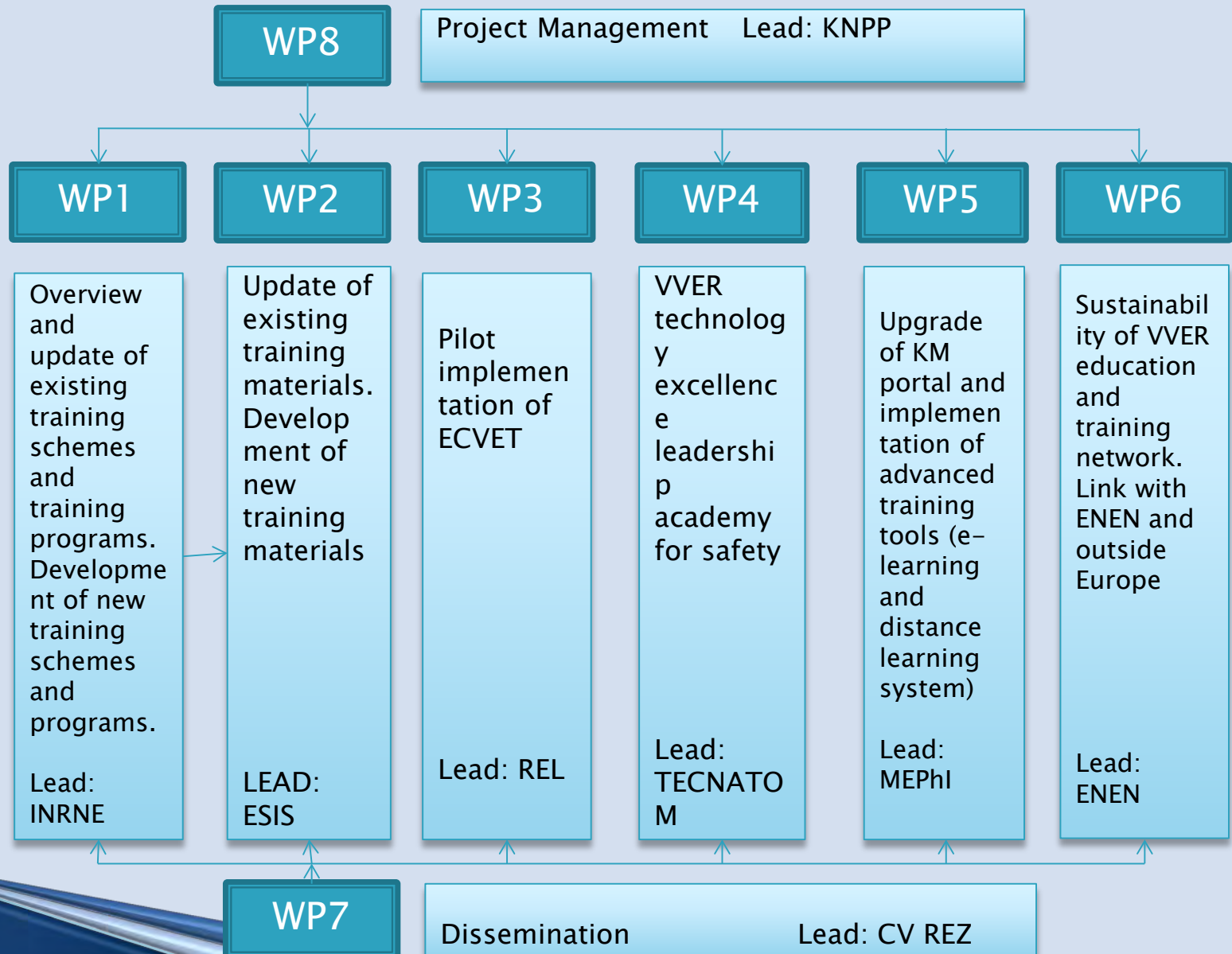



Objectives

- To apply the set of activities towards pilot implementation of European Credit System for Vocational Education and Training (ECVET)
- To analyse the results and identify potential problem areas
- To discuss and coordinate the work with other organizations performing trial implementation of ECVET



Steps

Select one particular job (define job profile) for pilot implementation, which is subject to increased mobility:

- Define competence requirements (KSCs and LO) for this qualification (Level 4 max Level 5, according to EQF);
- Select appropriate training scheme for this qualification, based on the defined units of LO;
- Select two utilities playing the roles of sending and host provider and organization playing the role for competent authority;
- Perform at least one pilot training on selected course;
- Recognise LO, perform validation. Validation means a process of confirmation by an authorised body that an individual has acquired learning outcomes measured against a relevant standard. Introduce training passport/certificate;
- Evaluate results and propose corrective measures.



Description of work

The work will be done through the following activities:

- Task 3.1: To select a qualification which is subject to increased mobility and permeability (where there is a significant degree of movement of personnel between countries). In such cases mutual recognition of education and training undertaken would be criterion for successful implementation and, consequently, some form of training “passport” advantageous – Lead partner: KNPP, Participants: REL, MEPHI, BME, ENEN
- Task 3.2: To define requirements for the knowledge, skills and competencies and LO for this qualification (define necessary knowledge, skill and competence items)- Lead partner: REL; Participants: ENEN, KNPP
- Task 3.3: To organize units of learning outcomes for the selected qualification – define, assess, validate, transfer and accumulate, recognize – Lead partner: REL; Participants: ENEN, KNPP
- Task 3.4: To select the appropriate training programs for this qualification, based on the defined units of LO, with objectives, target audience(s), audience prerequisites, required topics, suggested durations and evaluation methods for both initial and refresher training – Lead partner: KNPP; Participants: MEPHI, BME

Description of work (continued)

- Task 3.5: To assign roles of the participants in the pilot implementation : host provider and sending provider and a competent authority for recognition of the training (for the pilot implementation) – Lead partner: KNPP, Participants: MEPHI, BME
- Task 3.6: To organise pilot sessions in order to monitor the effectiveness of the proposed methodologies. The courses can be organised traditionally and/or electronically (e.g. using e-learning or distance learning) – Lead partner KNPP, Participants: MEPHI, BME
- Task 3.7: To set up the framework, the criteria and the procedure for the mutual recognition of curricula, courses and training sessions supporting the training. To introduce a European transcript of record (training passport) as an instrument for the implementation of the mutual recognition of vocational training in different countries – Lead partner - REL.



CONTACT DETAILS



Headquarters:

10, Vihren str.

Sofia 1618

Bulgaria

Tel. + 359 2 8089 703

Fax: +359 2 9507 751

riskeng@riskeng.bg

www.riskeng.bg

THANK YOU!



The ANNETTE Proposal

*3rd ECVET Seminar for the Nuclear Energy Sector
Hotel Nord Nuova Roma, Rome (Italy)
12 - 14 November 2014*

Walter Ambrosini and Pedro Diequez Porras

President and Secretary General of ENEN



General Characteristics

The *ANNETTE* Proposal has been submitted to the Euratom call under NFRP-10 within September 17th, 2014

It required an effort spent during last spring (for the first ideas) and last summer

The proposal is worth an EC request of 2.5 MEuros, with a total cost of about 3.2 MEuros

An effort was made in order to involve a large number of participants (27), also owing to the focus on coordination of the first work package

ANNETTE
**Advanced Networking for Nuclear Education and Training
and Transfer of Expertise**

Proposed logo:



Abstract

The present situation of nuclear energy in Europe asks for a continuing effort in the field of Education and Training aimed to assure a qualified workforce in the next decades.

In this scenario, the present proposal is aimed at enhancing and networking the Europe-wide efforts initiated in the past decades by different organisations belonging to academia, research centres and industry to maintain and develop Education and Training in the nuclear fields. This will allow consolidating, developing and better exploiting the achievements already reached in the past and to tackle the present challenges in preparing the European workforce in the nuclear fields.

The main objectives of the proposal are:

- 1. SURVEY AND COORDINATION OF NETWORKING IN E&T AND VET IN THE NUCLEAR AREAS*
- 2. DESIGN AND IMPLEMENTATION OF COORDINATED E&T AND VET EFFORTS (Master and Summer Courses for continuous professional development)*
- 3. GENERATIONAL TRANSFER OF EXPERTISE (Sustainable production of educational material)*
- 4. CROSS BORDER TRANSFER OF EXPERTISE (Implementation of ECVET based exchanges among industrial bodies)*
- 5. REINFORCING ETI ACTIONS FOR SHARING AND ENHANCING NUCLEAR SAFETY CULTURE COMPETENCE*
- 6. FACILITATING THE NUCLEAR TRANSITION IN FUSION: COORDINATING THE E&T ACTIONS*

The European Nuclear Education Network (ENEN), as coordinator of the proposed action, together with the other Participants, is committed to pursue the above objectives, being fully coherent with the ones suggested in the call (NFRP10) and proposed by the SET Plan Roadmap for Education and Training for the nuclear sector, tightening at the same time the links among the different nuclear areas and better coordinating their contributions in the E&T fields. Strict links with the SNE-TP; IGD-TP and MELODI platforms and other relevant associations and bodies (EHRO-N, NUGENIA, EUTERP, IAEA, HERCA, etc.) will be implemented to assure coherence of this effort with similar other efforts going on in Europe.

Master and Summer School for CPD

Production of teaching material

ECVET application in industry

Initiatives for NSC enhancement

FUNCTIONAL SKETCH OF THE PROJECT

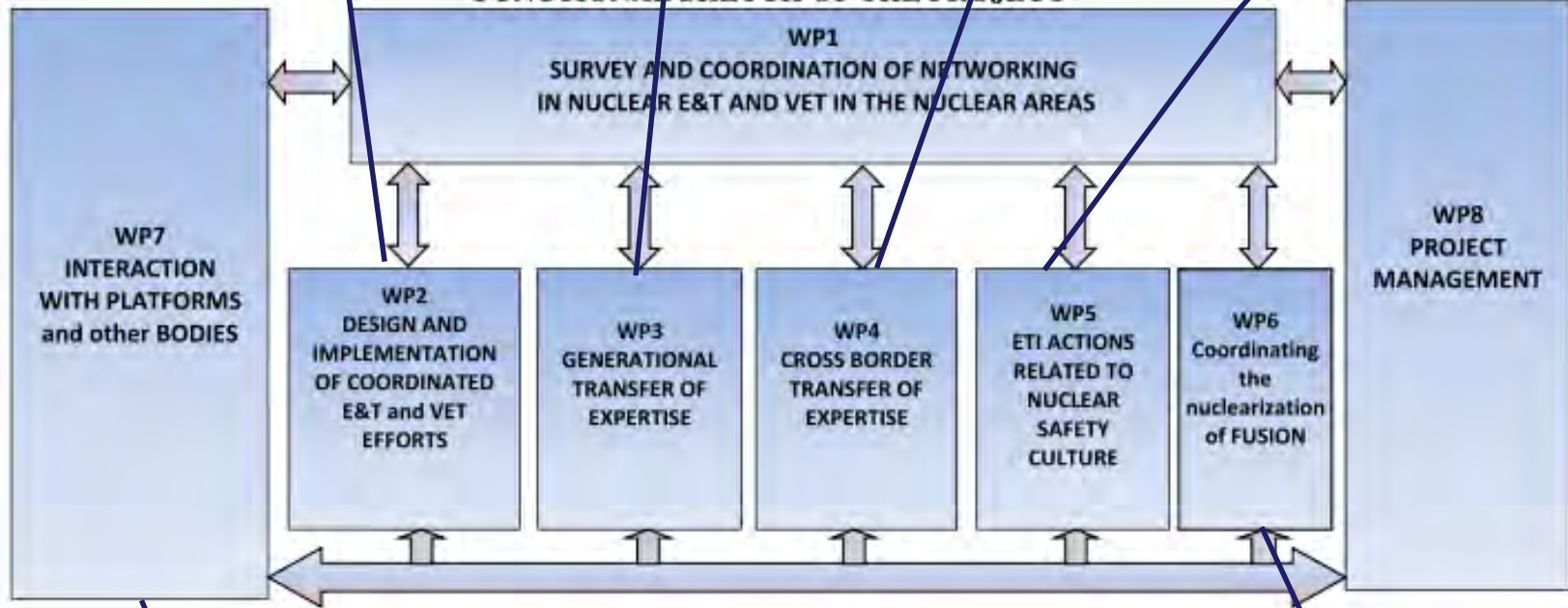

Contacts with Platforms, etc.

FuseNet asked to join to coordinate «nuclearization»

Tasks in WP1

| Task ID | Work Package and Task Description |
|---------|--|
| | Work Package 1 - SURVEY AND COORDINATION |
| T1.1 | SURVEY ON STATE OF THE ART IN E&T AND VET IN NUCLEAR |
| T1.2 | EXPLORE SUSTAINABLE ADVANCED NETWORKING MECHANISMS |
| T1.3 | STUDY OF TOOLS FOR INFORMATION EXCHANGE |
| T1.4 | EUROPEAN CERTIFICATIONS FOR E&T AND VET |
| T1.5 | QUALITY CRITERIA FOR EVALUATING E&T AND VET ACTIVITIES |
| T1.6 | SURVEY OF AVAILABLE NUCLEAR FACILITIES FOR LLL |

Participants

27 participants who answered in time of vacations and proposed interesting contributions (e.g., courses)

Though we could not involve everybody, we believe that ANNETTE may be an “open” project: in-kind contributions are possible and welcome (e.g. courses already in place...)

If funded (cross fingers!) it will possibly constitute a remarkable effort in the field

A positive dynamics already started...

- Joint E&T actions in NS&E, RP, WM and GD are envisaged
- The idea was proposed to **MELODI** and **IGD-TP**, receiving an early endorsement; **EHRO-N** also supported it and recently we received endorsements from **SNE-TP**, **FORATOM** and **ENS**, the **GENTLE** project, **ESARDA**, together with the **NUGENIA** label
- Colloquia with **IAEA** revealed the large potential for extending this action beyond European borders in due time

**COORDINATION IN E&T
IS A WIDELY RECOGNISED MUST**

Thank you for your attention !

European Nuclear Education Network Association
Centre CEA de Saclay – INSTN – Bldg 395
F-91191 Gif-sur-Yvette Cedex, France

Tel ☎ +33 1 69 08 97 57
Fax +33 1 69 08 99 50
E-mail sec.enen@cea.fr

www.enen-assoc.org

3rd ECVET Seminar – customized for Nuclear Energy Sector



Prospective- Discussions



3rd ECVET Seminar for NES

1. Working team

Coordinator

Participants





3rd ECVET Seminar for NES

1. Working team

Coordinator

Robert Hans van WEZEL

Thierry LEFEUVRE

Andrea BUCALOSSI

Participants

B. BAZARGAN SABET

M. ILIEVA

Th. BERKVENS

M.
KUGLSTATTER

O. COMSA

P. LIVOLSI

G. CONSTANTINI

A. MADONNA

C. FAZIO

G.L. PAVEL

A. HEFNER

W.
AMBROSINI

J. IGLESIAS MORAM

C. SEGOT



3rd ECVET Seminar for NES

2. Seminar objective & achievements

| | Objectives | Achievements |
|----------------------------|---|---|
| Main objective | To support the national networks to set up an NUC-VET PP | |
| Specific objectives | O1) Analysis of possible funding sources | <ul style="list-style-type: none">- E+ the main funding source for NUV-VET PP- Other sources: Horizon 2020- Need for a "customized" funding source → a dedicated call NUC-VET PP |
| | O2) Updating the knowledge of the ECVET fundamentals | <ul style="list-style-type: none">- got a better understanding of ECVET concepts |
| | O3) Customizing the ECVET toolkit for NES | <ul style="list-style-type: none">- Tools for nuclear qualif. design: LU+LOs+Training programme |
| | O4) Identification of the processes that could be tested | <ul style="list-style-type: none">- It depends on the National NUC-VET networks |



3rd ECVET Seminar for NES

3. Next steps

| Topics | Discussions |
|--|---|
| The potential of NUC-VET networks to apply for a pilot project | <p>a) National NUC-VET networks should be activated:</p> <ul style="list-style-type: none"> - identification of industrial stakeholders- ECVET implement. + qualif. to be nuclearized - preparation of MoU |
| | <p>b) European NUC-VET networks</p> <ul style="list-style-type: none"> - ENEN, Petrus III & ENETRAP III & Corona have potential to submit application - question: to follow the pilot project format-nuclearization process (qualification) in the context of mobility? |
| If another ECVET Seminar would be useful? | - When & where? |
| Any other initiatives: | Olivia Comsa |
| | |



3rd ECVET Seminar for NES

**Thanks to all participants and
facilitators for the
hard and efficient work !**